

Technical and Economic Aspects of Load Following with Nuclear Power Plants



Nuclear Development

Technical and Economic Aspects of Load Following with Nuclear Power Plants

© OECD 2011

NUCLEAR ENERGY AGENCY
ORGANISATION FOR ECONOMIC CO-OPERATION AND DEVELOPMENT

Foreword

Nuclear power plants are used extensively as base load sources of electricity. This is the most economical and technically simple mode of operation. In this mode, power changes are limited to frequency regulation for grid stability purposes and shutdowns for safety purposes.

However for countries with high nuclear shares or desiring to significantly increase renewable energy sources, the question arises as to the ability of nuclear power plants to follow load on a regular basis, including daily variations of the power demand.

This report considers the capability of nuclear power plants to follow load and the associated issues that arise when operating in a load following mode. The report was initiated as part of the NEA study “System effects of nuclear power”. It provided a detailed analysis of the technical and economic aspects of load-following with nuclear power plants, and summarises the impact of load-following on the operational mode, fuel performance and ageing of large equipment components of the plant.

Acknowledgements

Valuable comments and contributions were received from Mr. Philippe Lebreton, Electricité de France, Dr. Holger Ludwig, Areva GMBH, Dr. Michael Micklinghoff, E.ON Kernkraft and Dr. M.A.Podshibyakin, OKB “GIDROPRESS”.

This report was prepared by Dr. Alexey Lokhov of the NEA Nuclear Development Division. Detailed review and comments were provided by Dr. Ron Cameron and Dr. Marco Cometto of the NEA Nuclear Development Division, Dr. Holger Ludwig from Areva GMBH, and other reviews and input from members of the NEA Nuclear Development Committee.

Table of contents

1	Introduction	9
1.1	Example: Electricity generation in France	10
2	The manoeuvring capability of past and modern nuclear power plants	17
2.1	Current utilities' requirements for manoeuvring capabilities	17
2.2	The manoeuvring capability of older and modern light water reactors	19
3	Technical aspects of load following with nuclear power plants.....	25
3.1	Physical aspects of the power generation and regulation.....	25
3.2	Operation of the NPPs with light water reactors.....	26
3.3	Influence of the load-following on the life-time expectancy of large components.....	41
3.4	Fuel performance in the load following mode	42
4	Economic aspects of load following	45
4.1	Load factor and the cost of electricity generation	45
4.2	Influence of the load-following on the equipment and the fuel	48
5	Conclusions	49
6	References	50

Figures

E.1:	Example of a typical power history during a cycle in a EDF reactor (in % of the rated power)	7
E.2:	Example of the electricity generation with some German nuclear power plants.....	8
1.1	Example of the electricity generation with some German nuclear power plants (PWR and BWR)	9
1.2:	Electricity generation in 2009 in France by source	11
1.3:	Example of the electricity generation in France during 2 weeks in November, 2010.....	11
1.4:	Average daily nuclear generation and daily variation of nuclear generation in France in 2010	12
1.5:	Example of the frequency variation on the grid in Europe.....	13
1.6:	Example of balance of electricity exchanges in France	14
1.7:	Example of a load patterns aver a 24 h period of time	14
1.8:	Approximate frequencies of different ramp rates in French NPP	15
1.9:	Approximate frequencies of the low-level power levels in French NPP.....	15
3.1:	General scheme of a pressurised water reactor (PWR)	27
3.2:	Turbine control in the power regulation mode	27
3.3:	Typical temperatures for French PWR 1300 MWe reactors as function of the power level.....	28
3.4:	Typical temperatures for German PWR as function of the power level.....	29
3.5:	Disposition of the control banks in the French PWR 900 MWe	30
3.6:	Regulation of the coolant average temperature in the PWR core with the control rods (PWR 900 MWe).....	31
3.7:	Example of the load following in the operation mode A	32
3.8:	Disposition of the black and grey banks in the French PWR 1300 MWe.....	33

3.9: Example of load following in a operational mode G.....	34
3.10: Disposition of the control banks in the French N4 reactor (PWR 1450 MWe)	36
3.11: Example of load following in a operational mode X (N4 reactor).....	37
3.12: General scheme of a conventional boiling water reactor (BWR).....	38
3.13: Schematic view of a BWR 8×8 fuel element and the control rod (cruciform).....	39
3.14: Schematic characteristic curve for BWR power regulation with recirculation pumps.....	39
3.15: Evolution of the BWR designs	40
3.16: VVER-1200 layout and the elements critical for the load following (orange arrows).....	42
3.17: Example of a typical power history during a cycle in a EDF reactor (in % of the rated power).....	43
3.18: Cracking of the fuel pellets of a PWR.....	44
4.1: Variation of LCOE as function of the load factor for main power sources.....	46
4.2: The projected costs of generating electricity as a function of the load factor	47

Tables

2.1: Load-following capability of older NPPs in France.....	20
2.2: KONVOI PWR design load cycling characteristics.....	21
2.3: Load-following capabilities of first serial VVER-1000 (Russian pressurised reactors)	21
2.4: Requirements (based on EUR) for the manoeuvring characteristics of AES-2006 with VVER-1200 .	23
3.1 Example of black and grey banks for PWRs fuel assemblies	33
4.1: Total Generation Cost Structure.....	45

Executive Summary

Nuclear power plants (NPPs) have been mainly seen as a base-load source of electricity. The main reason for this is that operating a NPP at the rated power level is usually more efficient economically and simpler. This mode of operation was possible because the share of nuclear in most countries' energy mixes was very small, and thus the need to vary the rated power arose only from safety needs (e.g. safe shutdowns in the case of load rejection) and frequency regulation required by the electric grid operator.

However that situation is changing in several countries. The share of nuclear power in the national electricity mix of some of these countries had become so important that the utilities had to implement or improve the manoeuvrability (load following) capabilities of their NPPs, to be able to adapt the electricity supply to daily or seasonal variations of the power demand.

For example, this is the case in France where more than 75% of electricity is generated with nuclear power plants (see Figure E.1).

Figure E.1: Example of a typical power history during a cycle in a EDF reactor (in % of the rated power)

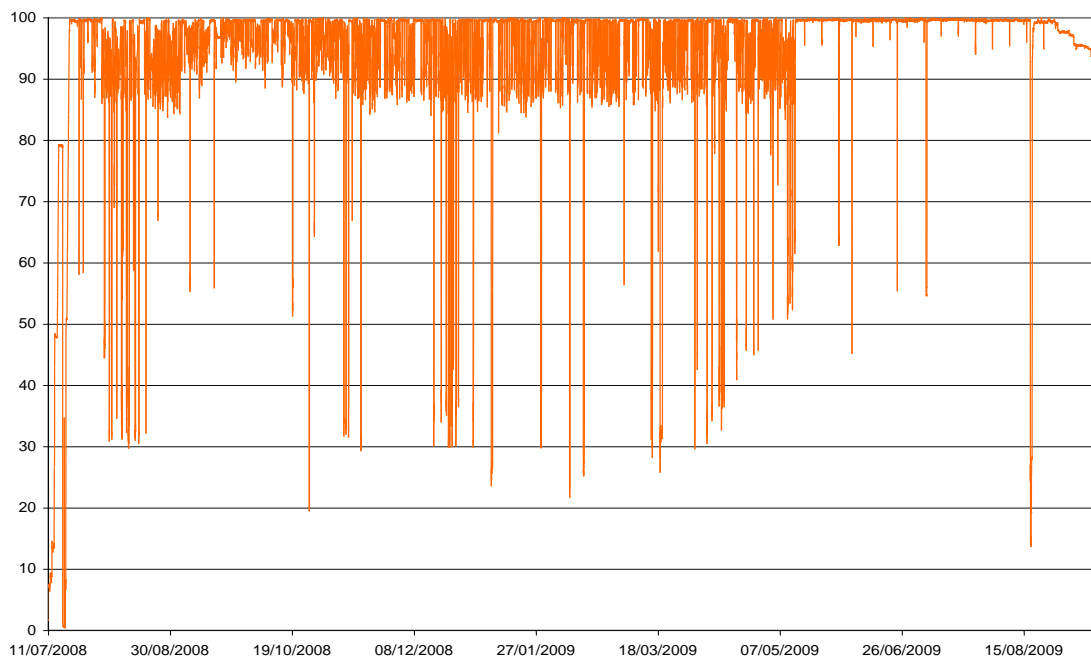

Courtesy of Électricité de France (EDF)

Another motivation for load following with nuclear power plants comes from the large-scale deployment of intermittent electricity sources (like wind power). If there is a significant share of intermittent and nuclear power sources on the same electricity grid, NPPs must be able to operate in a load following mode to balance the fluctuations of the total power generation, and in this case unexpected large and rapid modulations of the power demand could occur (see Figure E.2).

Figure E.2: Example of the electricity generation with some German nuclear power plants.

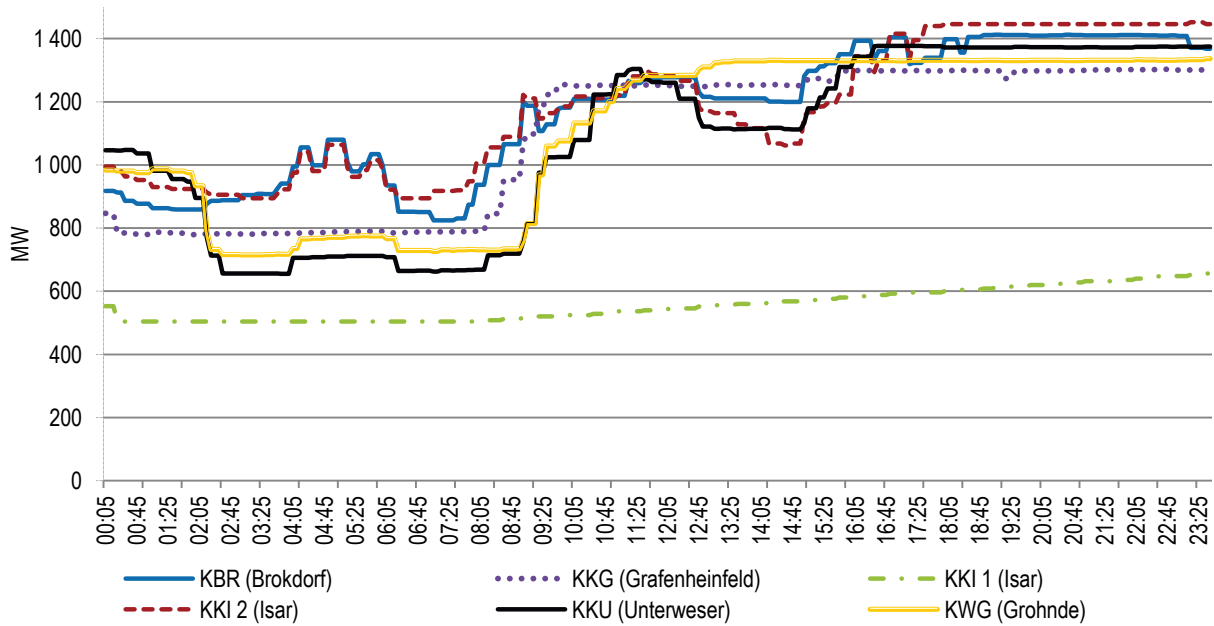

Courtesy of E.ON Kernkraft

Modern nuclear plants with light water reactors are designed to have strong manoeuvring capabilities. Nuclear power plants in France and in Germany operate in load-following mode, i.e. they participate in the primary and secondary frequency control, and some units follow a variable load programme with one or two large power changes per day.

The minimum requirements for the manoeuvrability capabilities of modern reactors are defined by the utilities requirements that are based on the requirements of the grid operators. For example, according to the current version of the European Utilities Requirements (EUR) the NPP must at least be capable of daily load cycling operation between 50% and 100 % of its rated power P_r , with a rate of change of electric output of 3-5% of P_r per minute.

Most of the modern designs implement even higher manoeuvrability capabilities, with the possibility of planned and unplanned load-following in a wide power range and with ramps of 5% P_r per minute. Some designs are capable of extremely fast power modulations in the frequency regulation mode with ramps of several percent of the rated power per second, but in a narrow band around the rated power level.

The economic consequences of load-following are mainly related to the reduction of the load factor. In the case of nuclear, fuel costs represent a small fraction of the electricity generating cost, if compared with fissile sources. Thus, operating at higher load factors is profitable for nuclear power plants, since they cannot make savings on the fuel cost while not producing electricity. In France, the impact of load-following on the average unit capability factor is estimated at about 1.2%.

Since most of the currently used nuclear power plants have been designed for strong manoeuvrability capabilities (except for some very old NPPs), there is no or very small impact (within the design margins) of load-following on acceleration of ageing of large equipment components. However, there is some influence of load-following on the ageing of some operational components (e.g. valves), and thus one can expect a slight increase of the maintenance costs. Also, for older plants some additional investment could be needed, especially in instrumentation and control, in order to become eligible for operation in a load-following mode.

1 Introduction

In the beginning of the nuclear power age nuclear power plants (NPPs) were mainly seen as a base-load source of electricity. The main reason for this is that operating a NPP at the rated power level is usually more efficient and simpler. Also, when nuclear power was introduced its share in the countries' energy mixes was very small, and thus the manoeuvring capabilities of the plant were typically limited to safety needs (e.g. safe shutdowns in case of load rejection) and frequency regulation.

Since that time the situation in several countries has changed. The share of nuclear power in the national electricity mix of some of these countries had become so important that the utilities had to implement or improve the manoeuvrability capabilities of their NPPs, to be able to adapt the electricity supply to daily or seasonal variations of the power demand. For example, this is the case in France where more than 75% of electricity is generated with nuclear power plants.

Another motivation for load following with nuclear power plants came from the large-scale deployment of intermittent electricity sources (like wind power). If there is an important share of intermittent and nuclear power sources on the same electricity grid, the NPPs must be capable to operate in a load following mode to balance the fluctuations of the total power generation, and in this case unexpected large and rapid modulations of the power demand could occur (see Figure 1.1).

Figure 1.1 Example of the electricity generation with some German nuclear power plants (PWR and BWR)

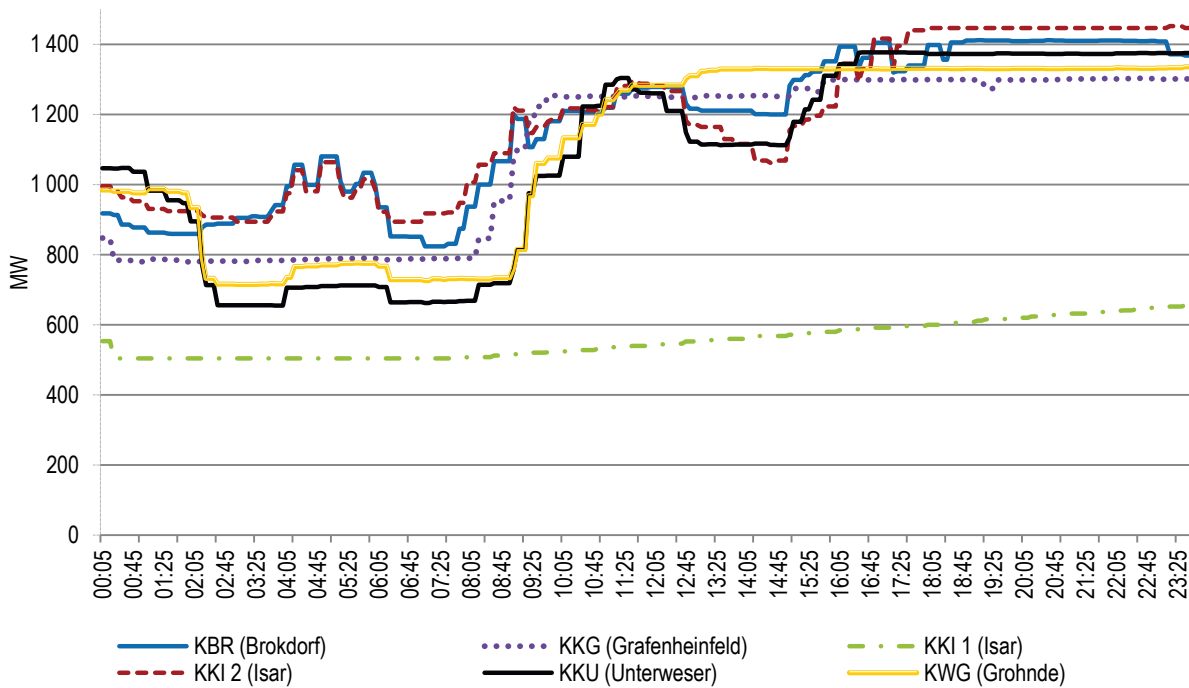

Courtesy of E.ON Kernkraft

In this report we discuss the changes in design that have been implemented in light water reactors in order to allow safe and efficient operation in a manoeuvring regime. In the first chapter, operation in the load-following mode in France is described. Next, the current utilities' requirements for the manoeuvring capabilities of advanced light water reactors are summarised. In the same chapter the manoeuvring capabilities of older and modern designs are summarised. In chapter 3, technical aspects regarding the operation in the load following mode with light water reactors are presented. In particular, the influence of manoeuvring on the ageing of the equipment and the performance of the fuel is discussed. In chapter 4, some general economic aspects of the operation in the load following mode are briefly analysed. The last chapter summarises the report.

In brief, most of the modern light water nuclear reactors are capable (by design) to operate in a load following mode, i.e. to change their power level once or twice per day in the range of 100% to 50% (or even lower) of the rated power, with a ramp rate of up to 5% (or even more) of rated power per minute. The manoeuvring capabilities needed and implemented for the frequency regulation of the grid are (in some cases) significantly higher, but the magnitude of the modulation is limited to a narrow power band (of several percent of the rated power) around the operational power level.

Today, some reactors in France and Germany operate in the load-following mode with large daily power variations of about 50% of rated power. In these countries, and also in some others, nuclear power plants participate in the frequency control on the grid.

In the case of pressurised water reactors (PWRs), the change of the reactors' power level could be performed by control rods movements and by changing the concentration of the boric acid (neutron absorber) in the primary coolant.

In the case of the boiling water reactors (BWRs), the power regulation is performed by changing the coolant flow rate (using the recirculation pumps) and/or¹ the control rods. No boron regulation is used in BWRs.

The operating modes have significantly evolved in the last 30 years. In a PWR, special dedicated control banks (so called "grey banks") are mainly used for the power regulation and efficient control of the power distribution. The boron regulation is less used today for daily power modulation since the change of the boron concentration is quite slow and the reactors operators try to minimise the use of boron to decrease the environmental impacts. In BWRs, significant improvements in the recirculation pumps design have been done, just as the number of the control blades (per fuel bundle) and their precision has been increased.

1.1 Example: Electricity generation in France

In France more than 75% of domestic electricity is produced at nuclear power plants. The remaining electricity is mainly generated by hydro power plants, but also some coal, gas and fuel oil plants (see Figure 1.2).

¹ The BWR designs that do not have recirculation pumps and use natural circulation in the vessel use the control rods for fine reactivity control (see discussion in the section 3.2.2).

Figure 1.2: Electricity generation in 2009 in France by source

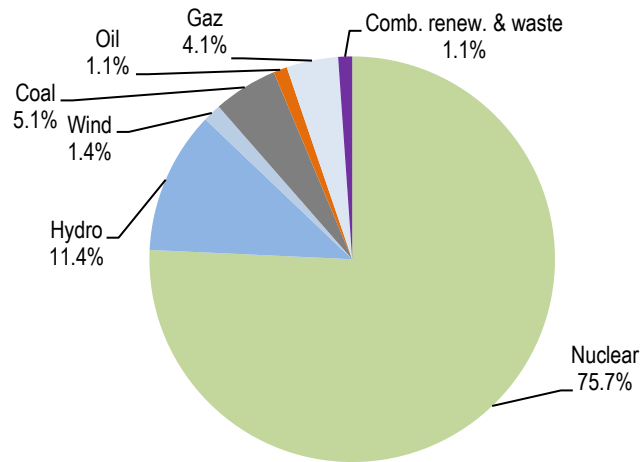

Source: IEA/OECD Electricity Statistics

Because the share of nuclear power in the national energy mix is high, some nuclear power plants operate in the load-following mode to respond to the daily variations of the electricity demand (see an example at Figure 1.3).

Figure 1.3: Example of the electricity generation in France during 2 weeks in November, 2010

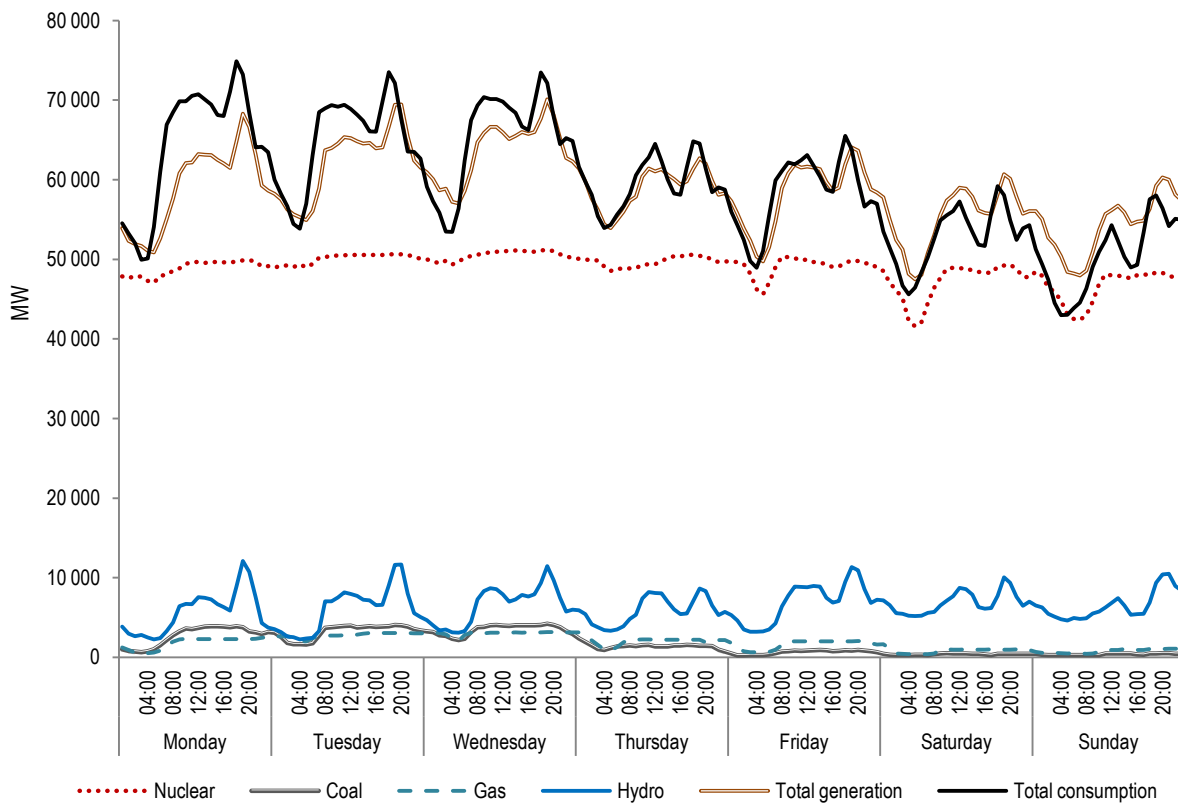

Source: Electrical Energy Statistics for France 2010, RTE (Réseau de transport d'électricité, France), <http://clients.rte-france.com/lang/fr/visiteurs/vie/telecharge.jsp>

Generally speaking there are four operating modes currently used by the power plants in France:

- base-load generation mode;
- primary and the secondary frequency control; and
- load-following mode.

A large part of the installed capacity operates at constant power in the base-load mode. Some nuclear and hydro power plants are used for load following. These modes are discussed below for nuclear power plants.

At Figure 1.4 the history of the total nuclear generation in France in 2010 is presented, and also the daily variation of the nuclear generation G (as percentage of the average nuclear generation for that day), defined as:

$$[\text{Daily variation of nuclear generation } G] = \frac{\frac{\max G}{24 \text{ h}} - \frac{\min G}{24 \text{ h}}}{\frac{\text{Average } G}{24 \text{ h}}}$$

With this definition, the daily variation of the nuclear generation is typically less than 5-10% of the total nuclear generation in France. The average daily variation of nuclear generation in 2010 is about 6.7%. However, for some periods, the daily variation could be superior to 20%. During the warm periods of the year the nuclear generation is lower (because the temperature of the cooling water is higher), and thus the daily variation is also higher.

Figure 1.4: Average daily nuclear generation and daily variation of nuclear generation in France in 2010

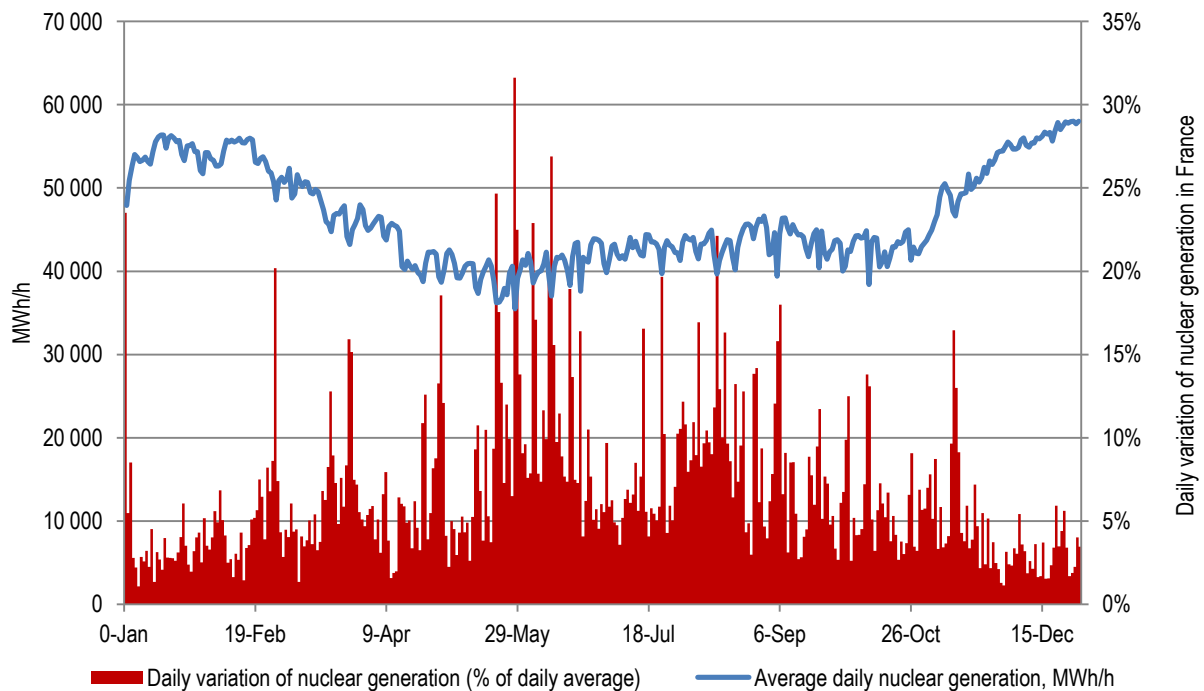

Source: RTE - Réseau de transport d'électricité (France), <http://clients.rte-france.com/lang/fr/visiteurs/vie/telecharge.jsp>

1.1.1 Base-load generation

In base-load mode, the nuclear power plants operate at constant power (usually at maximum rated power P_r) during almost the whole cycle. The first French NPPs of 900 MWe initially operated in this mode. Later, they were upgraded to improve their manoeuvrability capabilities (see Section 3.2.2 for details). Today, a significant part of French nuclear power plants operate in the base-load mode.

1.1.2 Primary and secondary frequency control

The power demand can never be exactly evaluated in advance and thus there is a certain random variation of demand resulting in frequency fluctuations (see Figure 1.5), typically of less than 20 mHz. The power plants have to monitor the frequency on the grid and immediately adapt their level of generation in order to keep the frequency stable at the desired value (**primary control**).

Figure 1.5: Example of the frequency variation on the grid in Europe

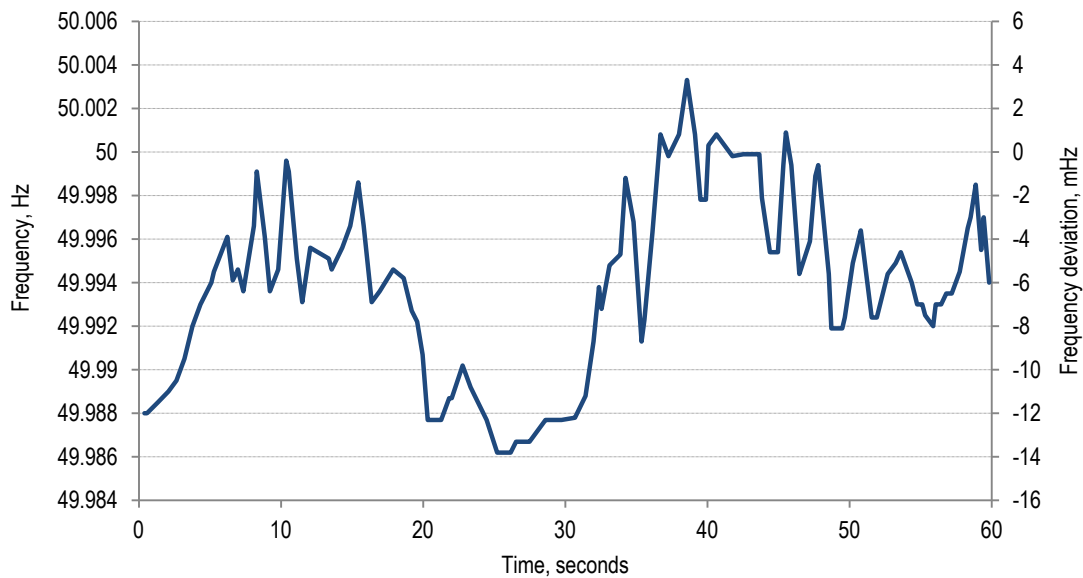

The variation of the frequency Δf would require a change of the power of the plant of:

$$\frac{\Delta P}{P_0} = \frac{1}{S} \frac{\Delta f}{f_0} \Rightarrow \Delta P = k \Delta f, \text{ with } k = \frac{1}{S} \frac{P_0}{f_0}$$

where f_0 is the target frequency (e.g. 50 Hz in France), P_0 is the power level of the plant (as % of the rated power P_r) and S is the droop measured in %; in France the droop is close to 4% (for nuclear and thermal power stations). Thus, one has in France

$$k \approx 50 \%P_r/\text{Hz}$$

and this means that if the frequency changes by $\Delta f \approx 20$ mHz, the power of the NPP would have to change by 1% P_r . The power modulations for the frequency regulation are performed in the interval of $\pm 2\% P_r$.

The primary frequency control allows short-term adjustment of electricity production and demand in the time frame of about 2 to 30 seconds after the deviation is observed. Another type of frequency

regulation (**secondary control**) acts over longer timeframes (say, from several seconds to several minutes) and restores the exact frequency by calculating an average frequency deviation over a period of time. The secondary control is particularly important because of the interconnection of the French grid with other European grids (see Figure 1.6). In order to adjust the frequency taking into account the balance of electricity exchanges with other European grids, the grid operator sends a digital signal to the NPP to modify their power level by in the interval of $\pm 5\%P_r$.

Figure 1.6: Example of balance of electricity exchanges in France

Balance of exchange programs for the day of 03/02/2011

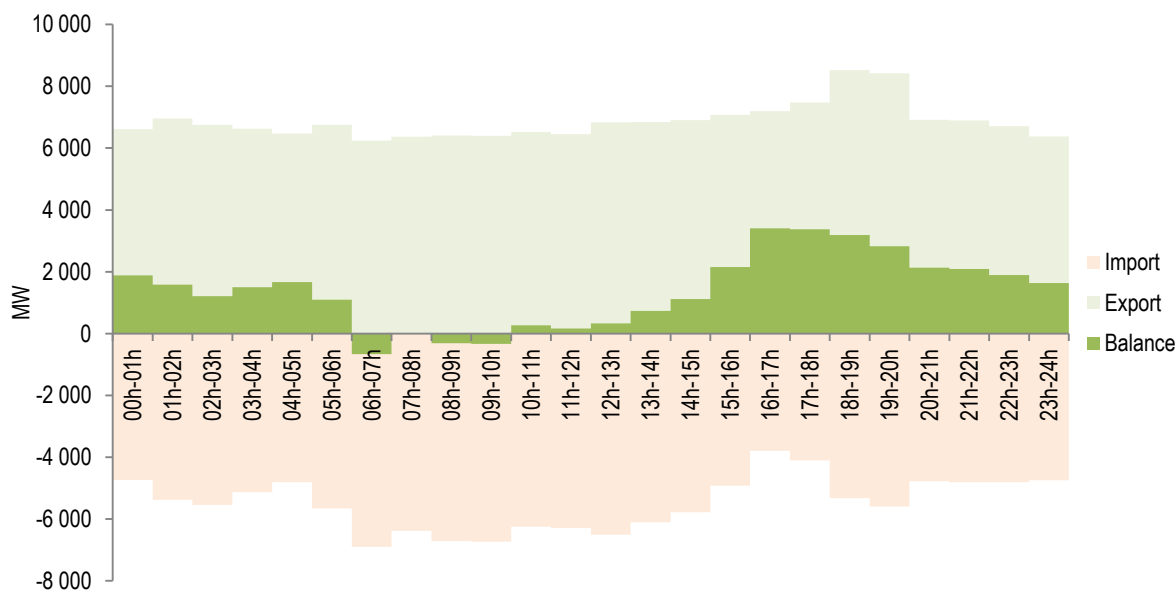

Source: RTE - Réseau de transport d'électricité (France), <http://clients.rte-france.com/lang/fr/visiteurs/vie/telecharge.jsp>

1.1.3 Load following

The nuclear power plants operating in the load following mode follow a variable load programme with one or two power changes per period of 24 h (see examples of the load patterns on Figure 1.7).

Figure 1.7: Example of a load patterns aver a 24 h period of time

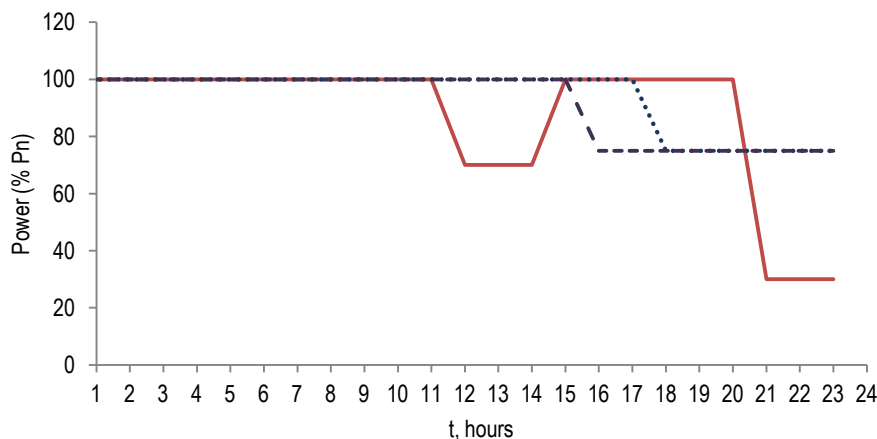

The load pattern is determined by the grid operator and the utilities, depending on the power demand and the manoeuvring capabilities of the plant. Depending on the load pattern, several intervals of power ramps are authorised ranging from 1% of P_r per minute (average rate) to about 5% of P_r per minute.

According to Cappolani, *et al.*, (2004), slow ramps of $\leq 1.5\%$ P_r per minute are most often used in France (see Figure 1.8) and the typical low power level is about 50% P_r (Cappolani, *et al.*, 2004, Figure 1.9). However, sometimes nuclear power plants operate at power levels below 50%.

Some plants operate in a special operating mode (18 hours at rated power and 6 hours at low power) with steep ramps of 2-5% of P_r per minute. In this mode the reactor is always capable of returning to the rated power level in a very short period, with a fast ramp of 5% of P_r per minute (Kerkar and Paulin, 2008).

Figure 1.8: Approximate frequencies of different ramp rates in French NPP

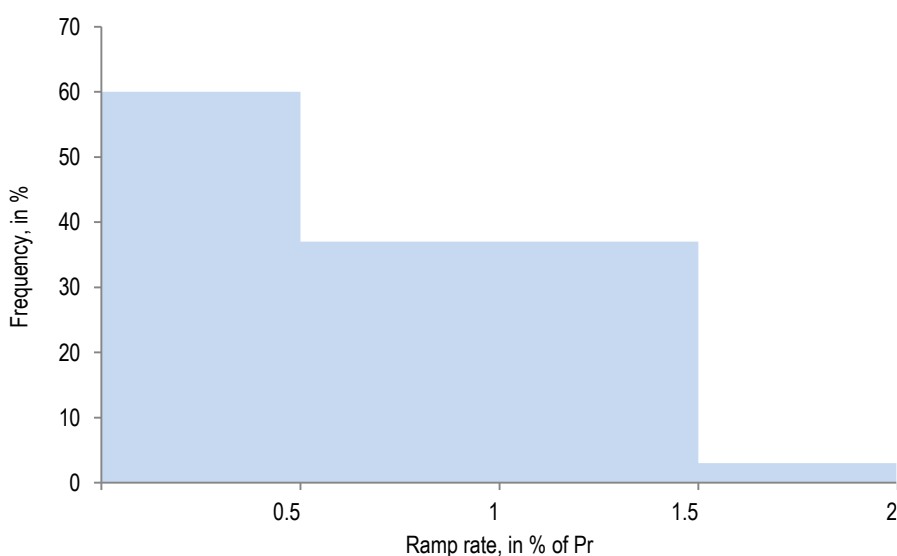

Source: Cappolani, *et al.*, 2004.

Figure 1.9: Approximate frequencies of the low-level power levels in French NPP

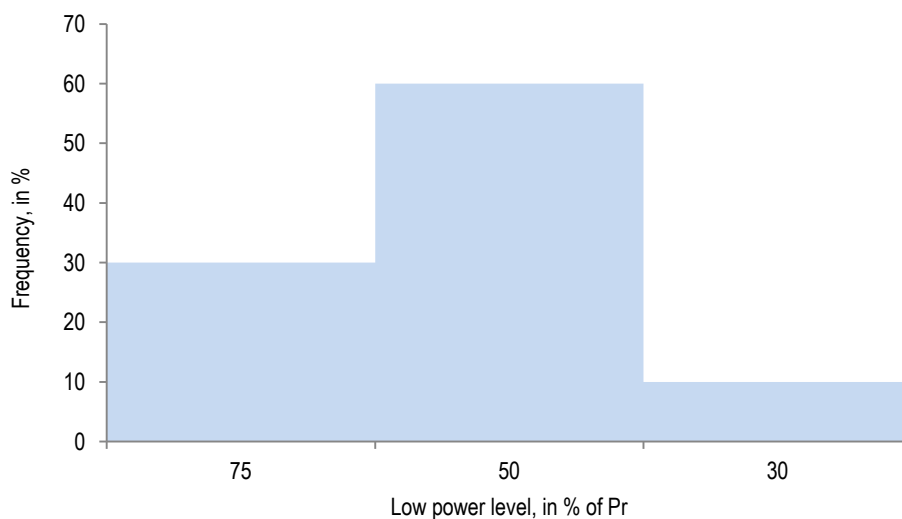

Source: Cappolani, *et al.*, 2004.

2 The Manoeuvring Capability of Past and Modern Nuclear Power Plants

2.1 Current utilities' requirements for manoeuvring capabilities

At the end of the 1980 utilities from the United States, Europe and Asia united their efforts in preparing the set of requirements for advanced light water reactors. In 1990, the first edition of the advanced light water reactors (ALWRs), utility requirements document (URD) was issued by the Electric Power Research Institute (EPRI) in the United States².

In 1991, five European utilities³ considered that a more open specification would be needed to cover a wider range of designs, and thus the European Utilities' Requirements (EUR) were created.

The EUR cover a broad range of conditions for a nuclear power plant to operate efficiently and safely. They include such areas as plant layout and specifications, systems, materials, components, probabilistic safety assessment methodology and availability assessment.

Although still requiring regulatory design approval in each country, EUR compliance indicates that the reactor design meets a list of requirements set by the utilities for the next generation of light water reactors (LWRs), and that could be proposed throughout Europe without any major design change. Plants certified as complying with EUR include very different designs: The AP1000, AES-92 (with VVER-1000/V-392), EPR, ABWR, KARENA and BWR 90.

The EUR explicitly state that modern reactors should implement significant manoeuvrability capability and, in particular, to be able to operate in the load-following mode.

According to the EUR requirements (EUR, 2001):

- **The unit must be capable of continuous operation between 50 and 100% of its rated power P_r (but not below the minimum power level).** However, the plant designer may provide a standard design that can be operated at a lower ratio of the rated power (typically down to 20%).

A lower level of minimum load can be required by the grid operator. When grid loading decreases (for instance, during nights and weekends) it enables a nuclear unit to be operated at low power without having to stop and start again when load increases, and also the unit's power output to be increased faster if a sudden need occurs.

The standard plant design shall allow the implementation of scheduled and unscheduled load following operation (i.e. drop in output followed by a plateau and an increase) **during 90% of the whole fuel cycle.** Restrictions are due to fuel conditions at the end of the cycle.

2. The current version of the ALWR URD could be obtained from <http://urd.epri.com/>.

3. The EUR founder companies were British Energy/Nuclear Electric, EDF, Tractabel and groups of German and Spanish utilities.

The unit shall be capable of load-following operation in the range of output from 100% P_r down to the minimum load of the unit. The rate of change of electric output shall be 3% of P_r /min. Higher values may be agreed between the plant operator and the grid operator. The unit shall be expected to go through the following number of load scheduled variations, each variation being defined as a transient from full power to minimum load and back to full power;

- 2 per day;
- 5 per week;
- Cumulatively 200 per year.

The load following shall be achieved in PWRs without adjusting soluble boron concentration during the manoeuvre.

For evolutionary BWRs the load following shall be achieved by recirculation flow control as much as possible, i.e. minimising control rods movements. For BWRs without recirculation pumps, there may be some deviations from the load following and cycling requirements.

The fuel shall be designed to avoid limitations on the rate of power increase for hot start-ups of the plant (start-up from Hot Shutdown Conditions, after operation at rated or near rated power, without having taken the plant to Cold Shutdown), as well as for cold start-ups.

- The unit may be required to participate in **emergency load variations**. The participation is based on an agreement between the grid operator and the operator of the unit. If the unit is requested to participate to emergency load variations, it shall at least be capable of fulfilling the following requirements (It is expected that this conditions occur only rarely, i.e. in average of once every 5 years):

Increasing of output: *according to requirements for secondary control.*

Decreasing of output:

- Amplitude: down to minimum load of the unit;
 - Rate of change: 20% of P_r /min.
- **The unit shall be capable of taking part in the primary control of the grid.** This is a prerequisite for connection to the grid. The primary control range shall be $\pm 2\%$ of the rated power P_r (mandatory), but Higher values may be agreed between system operators and plant operators, though not higher than $\pm 5\% P_r$.

The primary control is the automatic action on the unit, based on local frequency measurement, within a timescale of a few seconds, to establish the balance between production and load, and to stabilise the frequency. The grid operator and the electricity production company will agree about which units will participate in primary control. All the units must be capable of participating but more often may not be requested to participate at a given time. Even so, the primary control shall be technically possible at all times (mandatory).

The unit shall be capable of activating, within 30s, the total primary range of control requested at a quasi-steady frequency deviation of ± 200 mHz, and maintaining supply for at least 15 minutes. The primary control band shall be available again 15 minutes after activation, assuming that the reference frequency has been attained again. This time is needed for the grid operator to completely activate the secondary control reserve and the minutes reserve in case of major disturbances.

- **The standard plant design shall allow the implementation of a secondary control (optional).** Participation in secondary control is based on an agreement between the grid operator and the electricity production company. The secondary control is a central control (manual or automatic) of selected regulating plants or units within an area to restore the frequency and the net power exchanges to their scheduled values (on a time scale of a few minutes). The specifications in detail are part of the agreement. The minimum control range for secondary control operation shall be $\pm 10\%$ of P_r above the minimum load taking into account the control range. Further details have to be defined in the agreement between system operator and plant operator. The variation rate shall be 1% of P_r/min . Higher values may be agreed between system operator and plant operator, though not higher than 5% of P_r/min .
- **The unit shall be able to contribute to grid restoration.** Re-supplying customers will be based on an agreement between the system operator and the plant operator. If the unit participates in re-supplying customers, it should be capable of withstanding sudden load steps up to 10% of P_r .

The requirement for the load following and manoeuvring capabilities of the nuclear power plants described in the Electric Power Research Institute (EPRI) “Advanced Light Water Reactor Utility Requirements Document” are very similar to those of the EUR.

Although the utilities’ requirements manoeuvring capabilities of the nuclear power plants are already quite strong, one can expect that an increased flexibility of all sources of electricity will be demanded by the grid operators. New regulations in this field are currently being prepared in the European Union, for example.

2.2 The manoeuvring capability of older and modern light water reactors

2.2.1 The manoeuvring capability of older designs

2.2.1.1 Older designs in France

When the first series of 900 MWe PWR was built in France in the 1970, the boron power regulation was widely used in transients (the so called mode “A”). The boron regulation is quite slow for daily load cycling, but has a considerable advantage because it does not affect the axial power distribution in the core. Even so, the boron regulation systems needed to be upgraded to allow daily load cycling. The flexible mode A has been developed, but the amount of the boric acid used in transients was still significant.

The new power regulation mode “G” appeared in the end of the 1970. It is based on the use of control rods of variable efficiency - so called **black banks** (the most efficient) and **grey banks** (several times less efficient than the black rods). The development of the grey banks started in the middle of the 1970. The first tests of assemblies with grey rods were tested in 1981 at the Tricastin NPP. The use of the grey rods, combined with variable average temperature of the primary loop, allowed significant increase of the manoeuvrability capabilities of the plant.

In the 1980, mode “X” started to be developed with an objective to increase the manoeuvrability of the plants and to allow better control of the axial power offset.

Different operation modes for French NPPs and their manoeuvrability characteristics are summarised in Table 2.1. One may notice a significant improvement of manoeuvrability capability through time. The evolution of these operating modes is discussed in details in the Section 3.2.2.

Table 2.1: Load-following capability of older NPPs in France

France				
Type of reactor	PWR-900		PWR-1300	N4
Deployment	> 1971		> 1977	> 1984
Operating mode	Mode A	Mode A (flexible)	Mode G	Mode X
Primary frequency control range	$\pm 2\% P_r$	$\pm 2\% P_r$	$\pm 2\% P_r$	$\pm 3\% P_r$
Secondary frequency control range	$\pm 3\% P_r$	$\pm 5\% P_r$	$\pm 5\% P_r$	$\geq 5\% P_r$
Load following ramps	2% P_r /min till 80% of the fuel cycle 0.2% P_r /min after 80% of the fuel cycle		5% P_r /min till 80% of the fuel cycle 2% P_r /min after 80% of the fuel cycle	5% P_r /min
Example of the load following	12-3-6-3 during 85% of the whole fuel cycle	Same as mode A	12-3-6-3 (during 85% of the whole fuel cycle) 18 \uparrow 6 \downarrow (during 80% of the whole fuel cycle) 16 \uparrow 8 \downarrow (during 80% of the whole fuel cycle)	12-3-6-3 (during 95% of the whole fuel cycle) 18 \uparrow 6 \downarrow (during 90% of the whole fuel cycle) 16 \uparrow 8 \downarrow (during 95% of the whole fuel cycle)
Limits to the load-following in different operating modes				
Operating mode	Mode A		Mode G	Mode X
Low-power continuous operation	Possible up to 85% of the fuel cycle		Possible up to 85% of the fuel cycle	Always possible
Capability for instant return to 100% P_r	Particle capability, limited in the amplitude (15-20% P_r) by the of speed the boron dilution		Full capability, no limits in the amplitude up to 85% of the fuel cycle	Full capability, no limits in the amplitude up to 85% of the fuel cycle
Return to programmed load pattern	Limited in the amplitude and in the speed		No limits in speed up to 90% of the fuel cycle	Always possible up to P_r and at any speed up to 95% of P_r

2.2.1.2 Older German designs

The pressurised water reactors developed by Siemens/KWU were designed for operation in the load following using the black banks (a small part called “D-Bank”, usually consisting of 4 control rods, used only for maneuvering) and the boron regulation (compensation of xenon and burn-up effects only). They had the following manoeuvrability characteristics (Aminov, *et al.*, 1990):

- step power variations with ramps of 60% of the rated power per minute, in the interval of 10% of the current power level;
- prolonged power level changing with rates of ± 10 , ± 5 , $\pm 2\%$ of the rated power per minute for power variations of less than 20, 50 and 80%, respectively.

The number of cycles allowed by the design was quite high, see Table 2.2 (compared to the needs in manoeuvrability at the time when these plants were designed).

Table 2.2: KONVOI PWR design load cycling characteristics

Daily load cycles (in % of P_r)	Number of cycles
10% (step change)	100 000
100% - 80% - 100%	100 000
100% - 60% - 100%	15 000 (i.e. daily cycling during 40 years)
100% - 40% - 100%	12 000

Source: Ludwig, *et al.*, 2010.

The manoeuvrability of older German BWRs is similar or even better than PWRs discussed above.

2.2.1.3 Older Russian designs

Russian pressurised water reactors used to be mainly operated in the base load mode. However, some tests and experiments on the operating modes with variable load have been performed since the 1980. For example, an operation mode with sinusoidal power changes (with a period of 20-30 h) was tried in the beginning of the 1980 with VVER-440 reactors in Germany (Reinsberg and Greifswald NPPs). The main objective of these tests was to increase the length of the fuel cycle, but also production of more power during the day than during the night.

The newer generation of large pressurised water reactors VVER-1000 (first series) had seen their manoeuvrability capabilities significantly increased (Aminov, *et al.*, 1990). This became possible because of considerable improvements of different systems: fast boric acid removal from the primary coolant, instrumentation and control (e.g. in-core measurements of the state of the active zone, better regulation of the power), automatic launching of the turbine, etc. The manoeuvring characteristics of the first serial VVER-1000 are summarised in the Table 2.3.

Table 2.3: Load-following capabilities of first serial VVER-1000 (Russian pressurised reactors)

Type of reactor	VVER-1000
Deployment	1980-ies (first series)
Interval of power variation (%P_r)	30-100 during the first 2/3 rd s of the fuel cycle 70-100 during the last 1/3 rd of the fuel cycle
Ramps (%P_r per minute)	3-4 % P_r /min (10-70% of the fuel cycle) 1-1.5% P_r /min (70-100% of the fuel cycle)
Number of changes of the rated state	
- Reactor shutdown with aftercooling	130 times over the lifetime
- Full power reductions with the speed of up to 2% P_r /min	5 000 times over the lifetime
- Start-ups from the "hot" state	5 000 times over the lifetime
- Start-ups from the "cold" state	130 times over the lifetime
- Step changes in the limits of $\pm 20\%$ of the power level	150 times over the lifetime

Source: Aminov, *et al.*, 1990.

2.2.2 The manoeuvring capability of some modern light water reactors

The modern or advanced light water reactors are those that satisfy the utilities requirements defined, for example, by EUR or EPRI/ALWR URD. Thus, all these designs satisfy the minimum manoeuvrability requirements described in the Section 2.1. For illustration, we present below the description of the manoeuvrability capabilities implemented in the EPR and VVER-1000/1200.

2.2.2.1 The manoeuvring capability of the EPR

The European pressurised water reactor EPR is certified by EUR, and thus it satisfies the manoeuvrability requirements described in the Section 2.1. Precisely, the EPR is designed for the following manoeuvring capabilities (see UK-EPR, 2009 and Areva, 2008):

- daily load follow cycles;
- intermediate power level from 2 to 10 hours;
- usual (“light”) and unusual (“deep”) load following.

Load follow enables planned variations in energy demand to be followed and can be activated between 25% P_r and 100% P_r . Two load follow profiles are provided:

- light load follow, between 60% P_r and 100% P_r , at a maximum speed of 5% P_r per minute (during 80% of the fuel cycle);
- deep load follow, between 25% P_r and 60% P_r , at a maximum speed of 2.5% P_r per minute (during 80% of the fuel cycle);
- for higher burnups, the maximal variation speed is to be defined.

Between the technical minimum power and nominal power the unit can supply:

- a reserve of $\pm 2.5\%$ P_r to the grid for primary frequency control with a maximum speed of 1% P_r /second;
- a reserve of $\pm 4.5\%$ P_r to the grid between the technical minimum and 60% P_r for secondary frequency control with a maximum speed of 1% P_r per minute;
- a reserve of $\pm 10\%$ P_r to the grid between 60% P_r and 100% P_r for secondary frequency control with a maximum speed of 2% P_r per minute;
- higher variation speeds are acceptable during major grid disturbance (e.g. 5% P_r per minute in remote control).

2.2.2.2 The manoeuvring capability of the AES-92 and AES-2006 with VVER-1000/1200

The manoeuvring capabilities of the recent Russian projects AES-92 and AES-2006 with VVER-1000/1200 (versions V-392 and V-491) have been significantly improved since the first series with versions (V-187, -302, -338, -320).

The project AES-92 with VVER-1000/V-392 is certified by EUR, and thus it satisfies the manoeuvrability requirements described in the Section 2.1.

The newer project AES-2006 with VVER-1200/V-491 is also designed according to the EUR requirements (Mokhov and Podshibiakin, 2010). These requirements and the number of cycles of various types are given in the Table 2.4.

Table 2.4: Requirements (based on EUR) for the manoeuvring characteristics of AES-2006 with VVER-1200

Regime	Number of cycles	Impact on the fatigue strength of the equipment
Changing of the reactor power of more than 2% P_r and less than 5% P_r (grid frequency control) with the speed of 1% P_r per second.	$7 \cdot 10^6$	No impact
Changing of the reactor power with the speed of more than 1% P_r per minute and less than 5% P_r per minute, and of magnitude of less than 10% P_r .	$5 \cdot 10^6$	No impact
Load following (with planned or unplanned schedule) with the speed of less than 5% P_r per minute in the power range 50% P_r to 100% P_r	15 000	Maximal number of cycles: 20 000
Reactor power changing in the power range 50% P_r to 100% P_r in emergency situations: <ul style="list-style-type: none"> – Power increasing with the speed of 5% P_r per minute – Power decreasing with the speed of 20% P_r per minute 	100	Maximal number of cycles: 20 000
Changing the reactor power by $\pm 10\%$ P_r with the speed of 5% P_r per second: <ul style="list-style-type: none"> – Power increasing by 10% P_r – Power decreasing by 10% P_r 	1 000 1 000	No impact
Changing the reactor power by $\pm 20\%$ P_r with the speed of 10% P_r per minute: <ul style="list-style-type: none"> – Power increasing by 20% P_r – Power decreasing by 20% P_r 	65 65	Maximal number of cycles: 20 000

A cycle means the power changing and a return to the initial power level.

Source: Mokhov and Podshibiakin, 2010.

The reactor is designed to operate in the daily load-following mode in the power interval of 100-50% of the rated power, and also to participate in the frequency control. Also, AES-2006 is capable of fast power modulations with ramps of up to 5% P_r per second (in the interval of $\pm 10\%$ P_r), or power drops of 20% P_r per minute in the interval of 50-100% of the rated power. However, the number of such very fast power variations is limited, and they are mainly reserved for emergency situations.

3 Technical Aspects of Load Following with Nuclear Power Plants

3.1 Physical aspects of the power generation and regulation

There are several important physical effects that limit the possibilities of power variations in a light water nuclear reactor:

- **Counter-reactions**

- **Moderator effect** (change in the temperature of the primary coolant)

When the temperature of the primary coolant rises it expands, and hence its density decreases. Because of this the neutron moderation is less efficient and the reactivity decreases. This is a stabilising effect for the reactor - when the temperature rises the power reduces.

On the other hand, the parasitic absorptions also decrease in this case of coolant temperature rising, and the reactivity is increased. However, this destabilising effect is very small (compared to the effect of the density variation).

If the coolant contains boric acid (strong neutron absorbent introduced into the core for the reactivity regulation purposes), then the decreasing of the coolant density also leads to a decrease in the boric acid concentration. Thus neutron absorptions are less effective, and the reactivity is increased.

In summary, if the temperature of the primary coolant is increased, the overall reactivity is decreased due to less efficient neutron moderation which is a stronger effect than the increase because of reduced neutron losses (absorption by boron and by water).

- **Doppler effect** (change in fuel temperature)

The Doppler effect of reactivity is mainly related to the resonant absorption of neutrons by ^{238}U . When the temperature of the fuel rises, the resonant absorption is enhanced, including the sterile neutron absorption by ^{238}U . Thus, the reactivity is decreased. The Doppler effect is an important stabilising effect.

- **Change in the power distribution in the core**

Variations of the reactor power level change the axial distribution of the coolant temperature, because the temperature gradient in the core changes. Locally the moderation properties are modified (moderation in the upper part of the core is less efficient than in its lower part). Thus, when the power increases, the power distribution is pushed to the lower part of the fuel.

- **Fission product poisoning**, especially the:

- **Xenon effect** (several hours after the change in the reactor power level)

Xenon-135 is an extremely strong neutron absorber (with a half-life of 9.17 h) that is produced during the fission of heavy nuclei. In fact, almost all ^{135}Xe is produced via another decay product - ^{135}I . Iodine-135 decays to ^{135}Xe with a period of about 6.6 h.

The production rate of ^{135}I is, in fact, almost directly proportional to the reactor power. But the production rate of ^{135}Xe mainly depends on the concentration of the ^{135}I . This means that if, for example, the reactor is shut down the concentration of ^{135}Xe would continue to increase during several hours. Xenon-135 is a very strong neutron absorber, and the increase of its concentrations brings large negative reactivity to the core.

If reactor power is increased, the ^{135}I concentration grows exponentially before it reaches the new equilibrium conditions. Because of higher neutron flux (corresponding to the increased power level) the concentration of ^{135}Xe drops and reaches a minimum after about 3 h. After this period of time, the concentration of ^{135}Xe (built from the newly accumulated ^{135}I) starts to grow.

If the reactor power is reduced, the ^{135}I concentration also decreases exponentially before it reaches the new equilibrium conditions. However, the ^{135}Xe continues to be generated from the ^{135}I accumulated in the core. Thus, the ^{135}Xe concentrations increased after reactor power reduction, and it passes through a maximum after about 7-8 hours.

In summary, the concentration of ^{135}Xe and the associated negative reactivity decreases (and pass by a minimum after ~ 3 h) when the power of the reactor is increased. The concentration of ^{135}Xe and the associated negative reactivity increase (and pass by a maximum after $\sim 7-8$ h) when the power of the reactor is reduced. The magnitude of the xenon reactivity effect depends on the power levels before and after variations.

Since the reactivity xenon effect is shifted in time with respect to the reactor power, it is a significant challenge for the manoeuvrability of the plant. If control rods are used for power variations, they deform the axial power distribution, and thus the axial distributions of ^{135}Xe . The management of these axial oscillations of the reactor power and ^{135}Xe is an additional effect making challenging the operation in the load-following mode with large magnitudes of power variations.

- **Fuel burn up**

- Fuel burn up has significant (indirect) influence on the manoeuvrability of the reactor. In the beginning of the cycle boric acid (or other neutron absorber) is used to compensate the initial reactivity of the core. The concentration of boron decreases with time. At the end of the fuel cycle the boron concentration is almost zero, and the control rods are in the upper position. Thus the margins for the manoeuvrability decrease.

3.2 Operation of the NPPs with light water reactors

3.2.1 Pressurised water reactors (PWR)

The quantity of electric power generated in pressurised water reactors depends on the temperature and pressure of the steam produced in the secondary circuit (see Figure 3.1). The saturation temperature T_{sat} of the steam produced in the steam generators determines the overall efficiency of the energy conversion (higher value of this temperature leads to higher value of the efficiency).

Figure 3.1: General scheme of a pressurised water reactor (PWR)

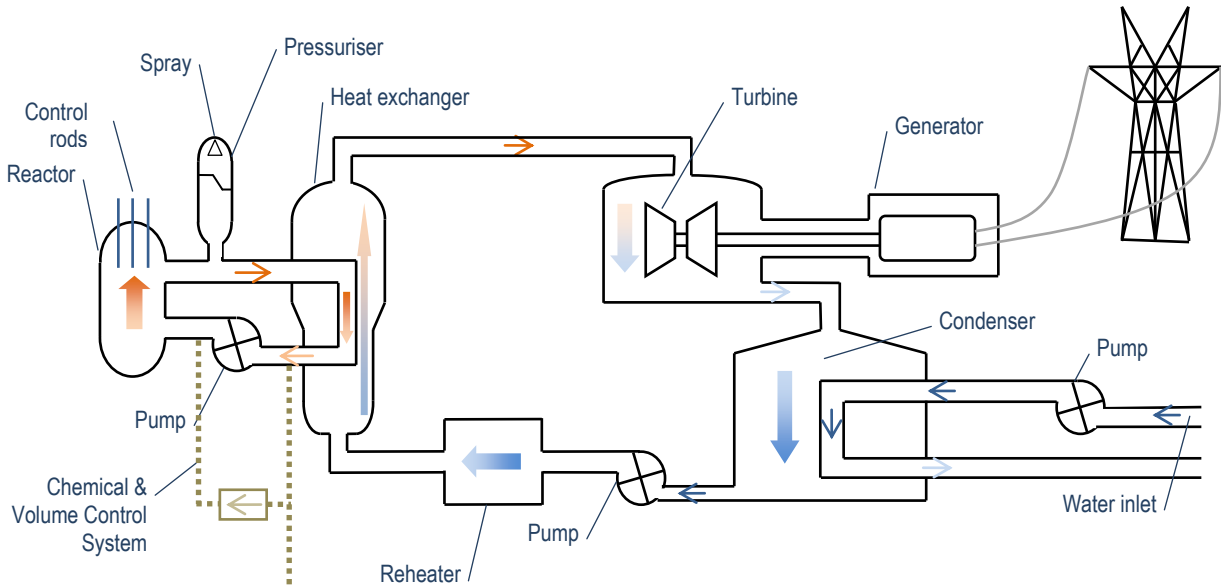

The temperature and the pressure of the coolant in the secondary circuit depend on the thermal power supplied by the primary one, and by the power consumed by the turbo generator. The scheme at the Figure 3.2 illustrates how the thermal power consumed by the turbo generator is regulated depending on the grid conditions and requirements: Primary frequency regulation, secondary frequency regulation and the load following. This regulation influences the state, i.e. the temperature and the pressure, of the secondary circuit.

Figure 3.2: Turbine control in the power regulation mode

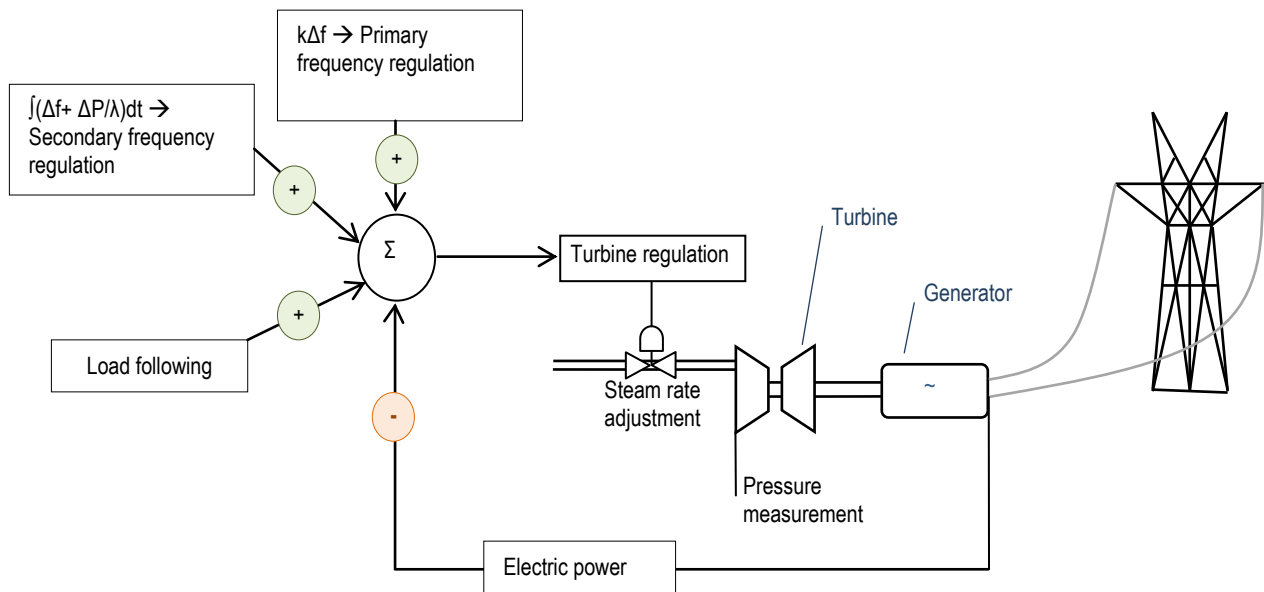

Source: Cappolani, *et al.*, 2004.

The thermal powers of the primary and the secondary circuit are equal (at equilibrium). One has two possibilities to balance the thermal powers of the primary and the secondary loops:

- Maintain the average temperature of the primary circuit constant.

The advantage of this option is that the volume of the primary coolant remains constant with power, and thus one would need a compact pressuriser. However, in this case the saturation temperature T_{sat} (and therefore the pressure) in the secondary loop increases with decreasing power and this leads to higher requirements for the steam generators design.

- The pressure in the secondary loop remains constant.

This means that the average temperature of the coolant in the primary circuit grows with power. The main advantage of this option is in high thermodynamic efficiency of the energy conversion, but more control rods would be needed in the core, and the pressuriser is larger than in the case of constant average temperature in the primary loop (to accommodate the variations of the volume of the coolant).

Various combinations of these options are possible, leading to similar thermodynamic efficiency. For example, in the French PWR 1300 MWe the average temperature of the primary coolant grows with power, and the pressure in the secondary loop decreases with power (see Figure 3.3). For the EPR, the solution adopted consists in using a mode with average temperature of the primary circuit growing with power in the power interval from 0 to 60% of the rated power, and constant primary coolant temperature in the interval of 60 to 100%. The secondary pressure decreases slowly in the interval 0 to 60% of P_r , and with higher speed of decreasing in the power range 60 to 100%. Similar strategy is used in some German PWRs (see Figure 3.4).

Figure 3.3: Typical temperatures for French PWR 1300 MWe reactors as function of the power level

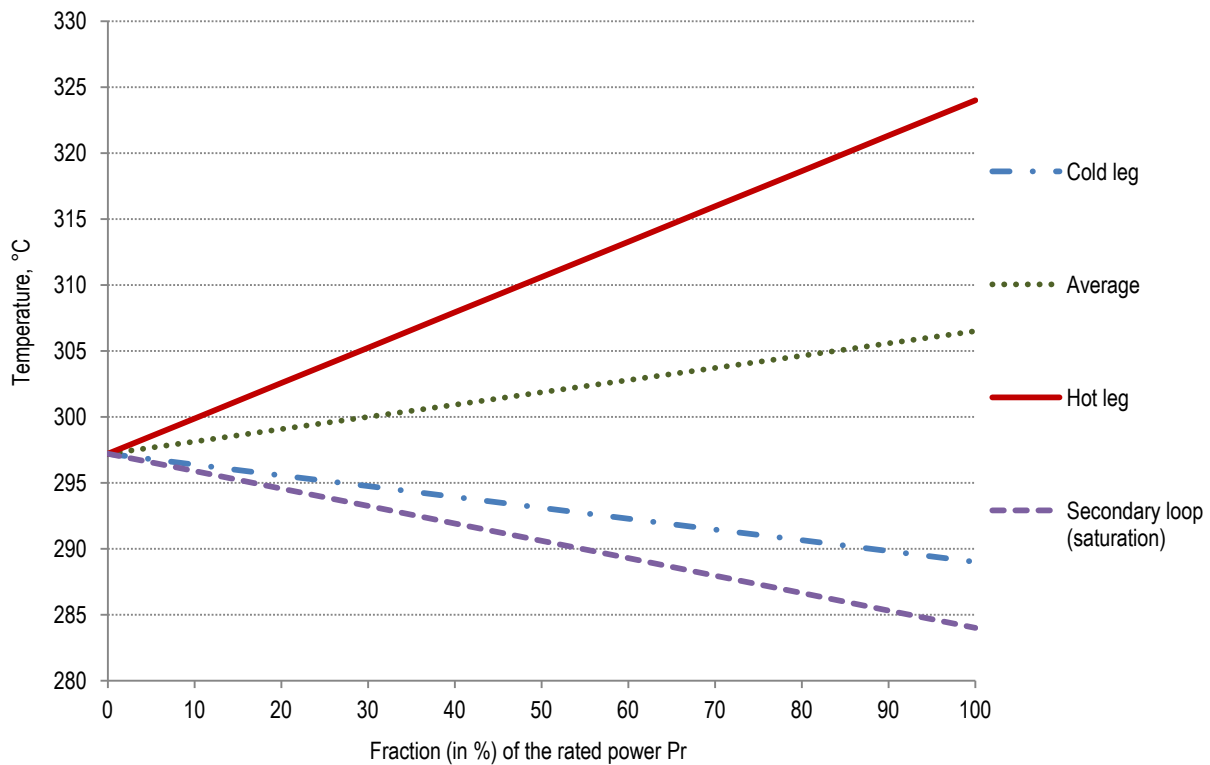
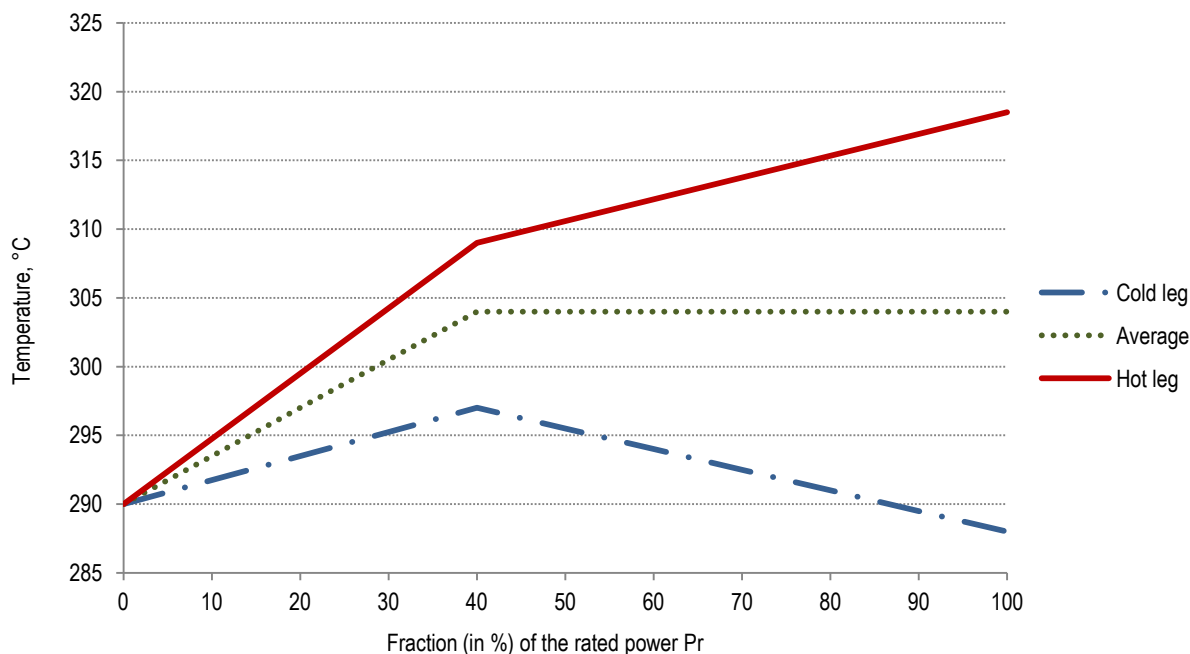

Figure 3.4: Typical temperatures for German PWR as function of the power level



Source: Ludwig, *et al.*, 2010.

3.2.1.1 Evolution of the operating modes of PWRs

As an example of the evolution of the operating modes we consider the case of French PWR and the operating modes A, G and X (summarised in the Table 2.1). The content of this section is mainly based on the Chapter 9 of Kerkar and Paulin (2008).

3.2.1.2 Mode “A” and the “Modified mode A”

In the mode “A”, used with the first French PWR, the regulation of the average temperature in the primary circuit is performed with the control rods. The operating mode “A” was modified (more precisely, some constraints were released) after the successful application of the mode “A” in the first units.

The control banks (all black banks, see Figure 3.8) are grouped in four groups A, B, C and D disposed as shown at Figure 3.5. The group D is used to compensate the small reactivity variations via the regulation of the average temperature in the core.

Also, the group D is used to control the temperature in the core (see Figure 3.6) and the **axial power difference parameter** ΔI defined as:

$$\Delta I = \frac{P_H - P_L}{P_H + P_L} \times P_0 = AO \times P_0$$

where AO is the **axial offset**, P_H and P_L is the power produced in the upper and lower parts of the core, and P_0 is the relative power level (as percentage of the rated power P_r).

Figure 3.5: Disposition of the control banks in the French PWR 900 MWe

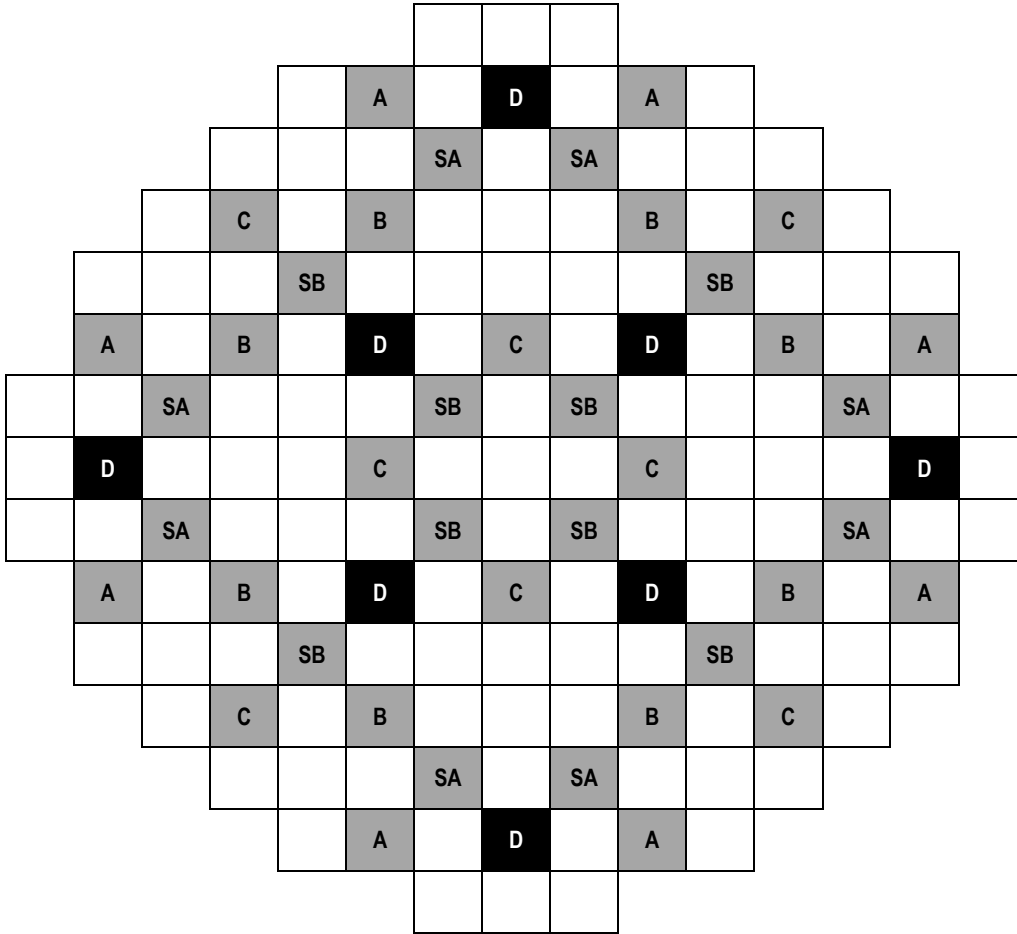

Source: Kerkar and Paulin, 2008.

In addition to the control rods, the boron management system (via the Chemical & Volume Control System, see Figure 3.1) is used to modify the concentration of the boric acid in the primary coolant. It is used to balance the fuel burn up, xenon and power variation effects.

Various safety constraints on the maximal local fuel heating rate (with regard to different accidental scenarios like LOCA) determine the operational domain depending on the reactor power and the axial offset ΔI . The reference axial power difference ΔI_{ref} is measured at stable power and stable xenon concentration, and with the control rods maximally withdrawn from the core. Then one has the following constraints for the modified operational mode "A":

- The power P_0 and the axial power difference ΔI must remain in the specially defined domain. In particular the values of ΔI should be less than 12% for the power range 15-75% P_r , and less than 8.4% at 90% P_r , and it should be located on the right hand side of the line $P=129.7+2.7 \Delta I$ (for negative values of ΔI). These limits are imposed to allow controlling the xenon oscillations in the core.
- In order to be allowed to increase the power level to more than 90% P_r the axial offset ΔI must remain in the above domain of values ($\Delta I, P_0$) domain for at least 12 hours.

The original operating mode “A” could not be used for the frequency regulation together with daily load following because of a constraint to operate in the narrow band of $\Delta I_{ref} \pm 5\% P_r$ at least for 12 h, to be authorised to increase the power to more than 87% P_r . The load following itself was significantly limited at the end of the fuel cycle, since the maximal rate of the power changing decreased from 2% P_r per minute (in the beginning of the cycle) to about 0.3% P_r per minute (at the end of the cycle), because of larger volume of water needed for boron regulation at the end of the cycle.

Figure 3.6: Regulation of the coolant average temperature in the PWR core with the control rods (PWR 900 MWe)

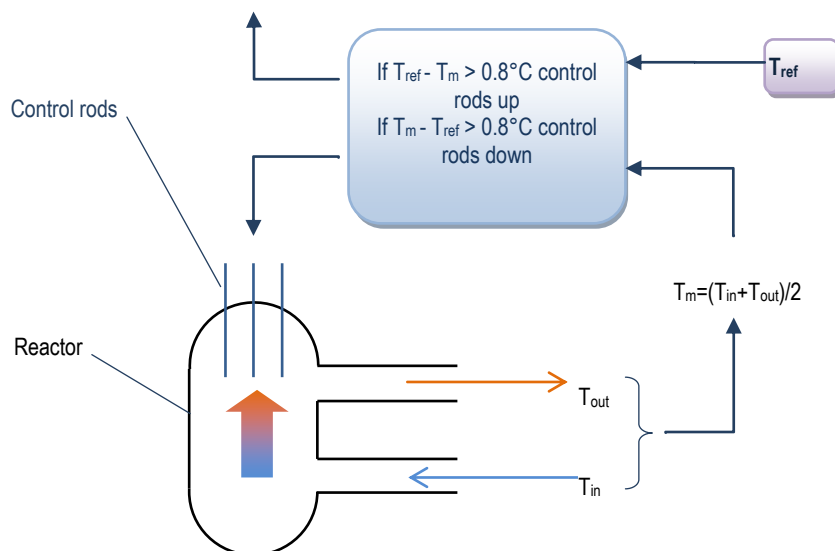

This constraint was removed in the modified mode “A”, and thus the reactors are capable of simultaneous load following and primary and secondary frequency regulation in the modified mode “A”.

Because of the constraints on the axial offset ΔI , the boric acid is used together with the control rods of the group D. The movements of the group D (with black rods) without using the bore would lead to a significant deformation of the axial power distribution, and thus the parameter ΔI would exit the authorised domain of values. Thus, for the load following in the mode A the following actions are performed:

- Decreasing the load
 - The group D (with black banks) is inserted.
 - Boron is added to the primary coolant to compensate the strong rise of the axial power difference ΔI .
- Operating at constant load (after the power has been decreased)
 - Removal of boron to compensate the xenon peak of negative reactivity.
- Increasing the load
 - Extraction of the D group.
 - Fast boron removal to compensate the power effect.

- Boron addition to compensate the reduction of the xenon antireactivity due to the power increasing.

The example of the load following in the mode A is shown at the Figure 3.7.

Figure 3.7: Example of the load following in the operation mode A

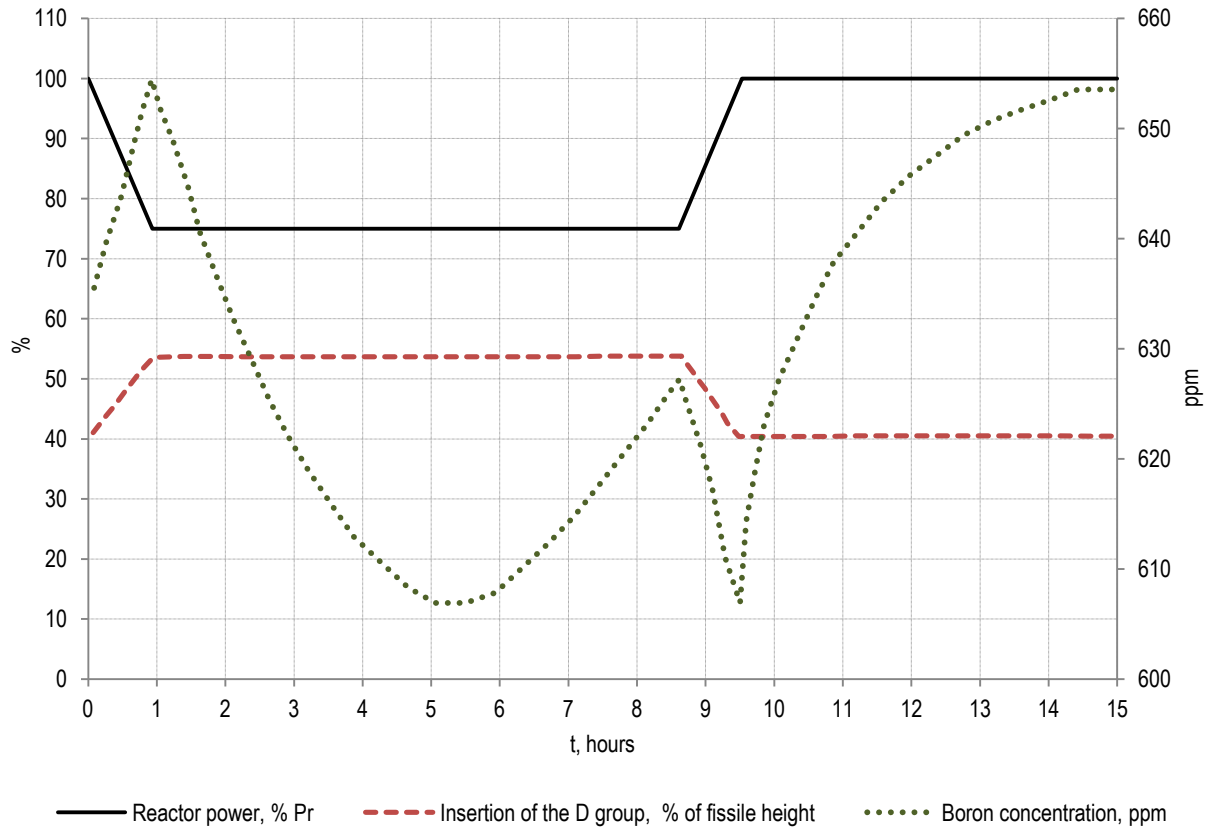

Source: Kerkar and Paulin, 2008.

The use of the boric acid in the load following has two significant disadvantages:

- The rate of the power variation is limited by the Chemical & Volume Control System.
- There is an important volume of effluents generated (because of the use of boron).

To overcome these disadvantages and a considerable perturbation of the axial power distribution by the black rods, an improved power management system and a new operation mode “G” was developed.

3.2.1.3 Mode “G”

The mode “G” is based on the usage of the control banks with smaller number of absorbing rods - the **grey banks**, allowing decreasing the deformation of the power distribution, what is particularly important for manoeuvrability of the plant (see Table 3.1).

In the mode “G” both control rods and the boric acid are used for the power regulation. An example of the disposition of the black and grey banks in the core of the French PWR 1300 is shown at the Figure 3.8. The groups G1 and G2 have grey banks, and all the others are the black ones.

Table 3.1 Example of black and grey banks for PWRs fuel assemblies

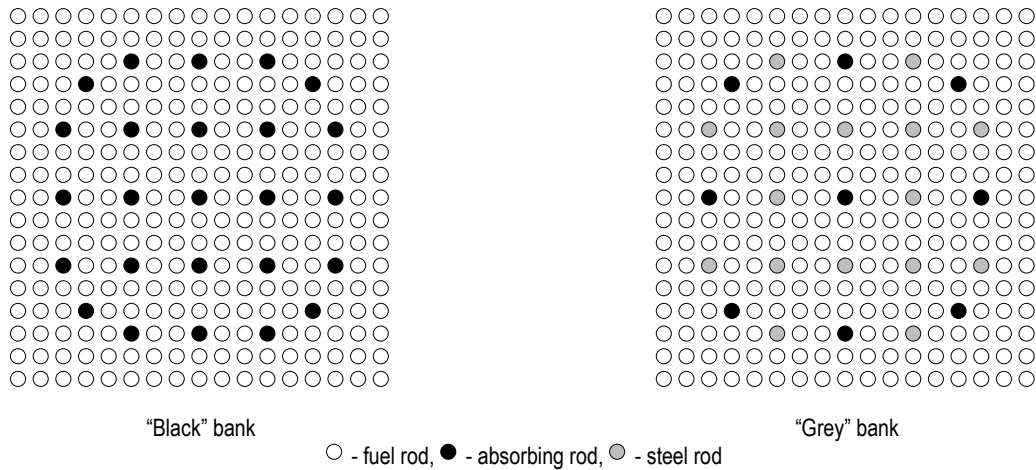
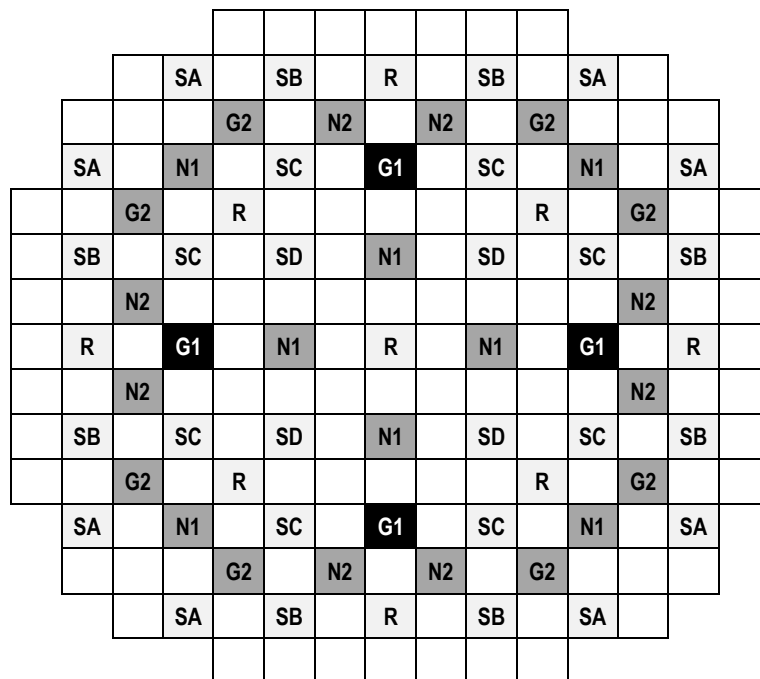

Figure 3.8: Disposition of the black and grey banks in the French PWR 1300 MWe



Source: Kerkar and Paulin, 2008.

The group R used to compensate the small reactivity variations via the regulation of the average temperature of the primary coolant. Is has a role similar to the group D in the mode “A” (see Figure 3.5 and Figure 3.6).

The groups G1, G2 (grey) and N1, N2 (black) are used to compensate the reactivity effects due to the power variations. At nominal power the grey groups are fully withdrawn, and they are inserted into the

core for operation at low power levels. When the power of the reactor is reduced, the coolant temperature, and thus the axial power distribution, is modified - the latter is pushed to the upper part of the core. This leads to an increase in the axial power difference ΔI . The insertion of the grey groups (sometimes in overlapping configurations) allows bringing the axial power difference ΔI to its initial value.

The boric acid is used to compensate the slow reactivity effects due to the xenon poisoning and fuel burn up. Less boron is used in the mode “G” than in the mode “A”, since the perturbation of the axial distribution is better controlled with the grey banks.

Figure 3.9: Example of load following in a operational mode G

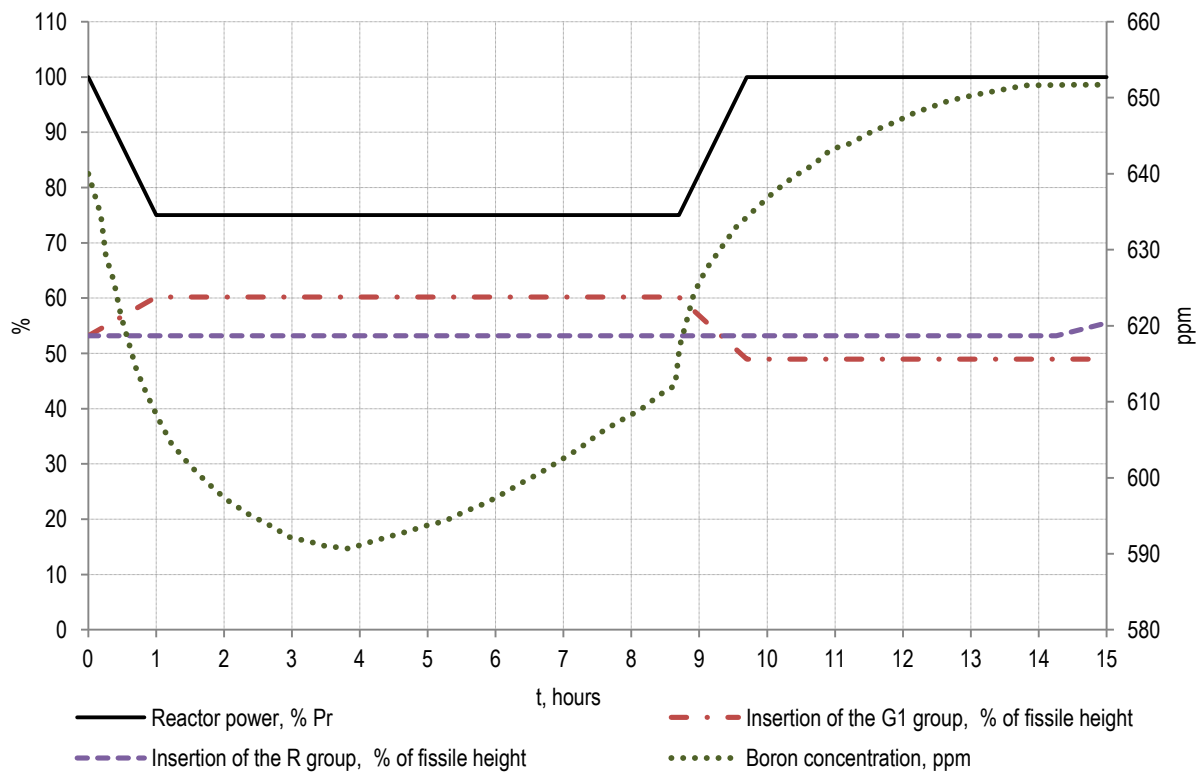

Source: Kerkar and Paulin, 2008.

The operational domain in the mode “G” is not limited in power. The reactor can, in principle, operate at any power level if the axial power difference ΔI is less than $5\% P_r$ at zero power and $\Delta I < \Delta I_{ref}$ at full power. The improvement of the original mode “G” made it possible to shift this limit to $\Delta I < 6\% P_r$ at full power (in the operating mode GEMMES).

For the load following, grey and black (group R) banks are used. For the frequency regulation the black group R is used for frequency deviation smaller than 60 mHz. In case of higher frequency deviations the grey groups are also used.

The main advantages of the operational mode “G” is that, compared to the mode “A”, are:

- Possibility of fast ramps:
 - $5\% P_r$ till 80% of the fuel cycle (compared to $2\% P_r$ in the mode “A”);

- 2% of P_r after 80% of the fuel cycle (compared to 0.2% P_r in the mode “A”).
- Possibility of fast return to full power.
- Lower volume of effluence produced (lesser boron used).
- Efficient control of the axial power offset using grey and black banks.

The main challenges of the operational mode “G” are the following:

- The constraints on the overlaps between the grey banks (needed for the operation) complexifies the fine positioning of the control rods. Because of this, operating at low power level may be challenging in some cases.
- The efficiency of the grey banks depends on the fuel burn up, and their calibration curves must be regularly adjusted.
- If the plant is operated in a simultaneous load following and the frequency regulation regime, it is difficult to distinguish between the xenon effects due to each mode (the xenon effect due to the load following is manually handled and the one due to the frequency regulation is automatically compensated by the group R).

3.2.1.4 Mode “X”

The mode “X” was developed to control the axial power offset and the average temperature of the primary circuit simultaneously, using the control rods. The boric acid is used to compensate the slow reactivity variations due to the xenon poisoning and fuel burn up. The first tests of this mode have been done in 1990-1991 at the unit 2 of the Saint-Alban NPP in France (PWR 1300 MWe).

Five groups are used in the operation (see Figure 3.10):

- X1: 4 grey banks
- X2: 4 black banks
- X3: 4 grey banks and 4 black banks
- X4: 8 black banks
- X5: 9 black banks.

The control banks are positioned in overlapping configurations: Some banks are situated in the upper part of the core (X2), and other in the lower part of the core (X1). Simultaneous movements of both banks allow efficient controlling of the power axial offset.

In the mode “X” the power axial offset and the average temperature of the coolant in the core is controlled simultaneously. All the control banks are used to regulate the temperature: If the average temperature in the core differs from the reference one for more than 0.8°C (see Figure 3.6). At the same time, the groups X1 and X2 are used to control the axial offset AO deviates from the reference value at more than 1%. The set of groups auctioned depend on the average temperature and axial offset deviation that are evaluated based on on-line measurements of the core parameters.

Figure 3.10: Disposition of the control banks in the French N4 reactor (PWR 1450 MWe)

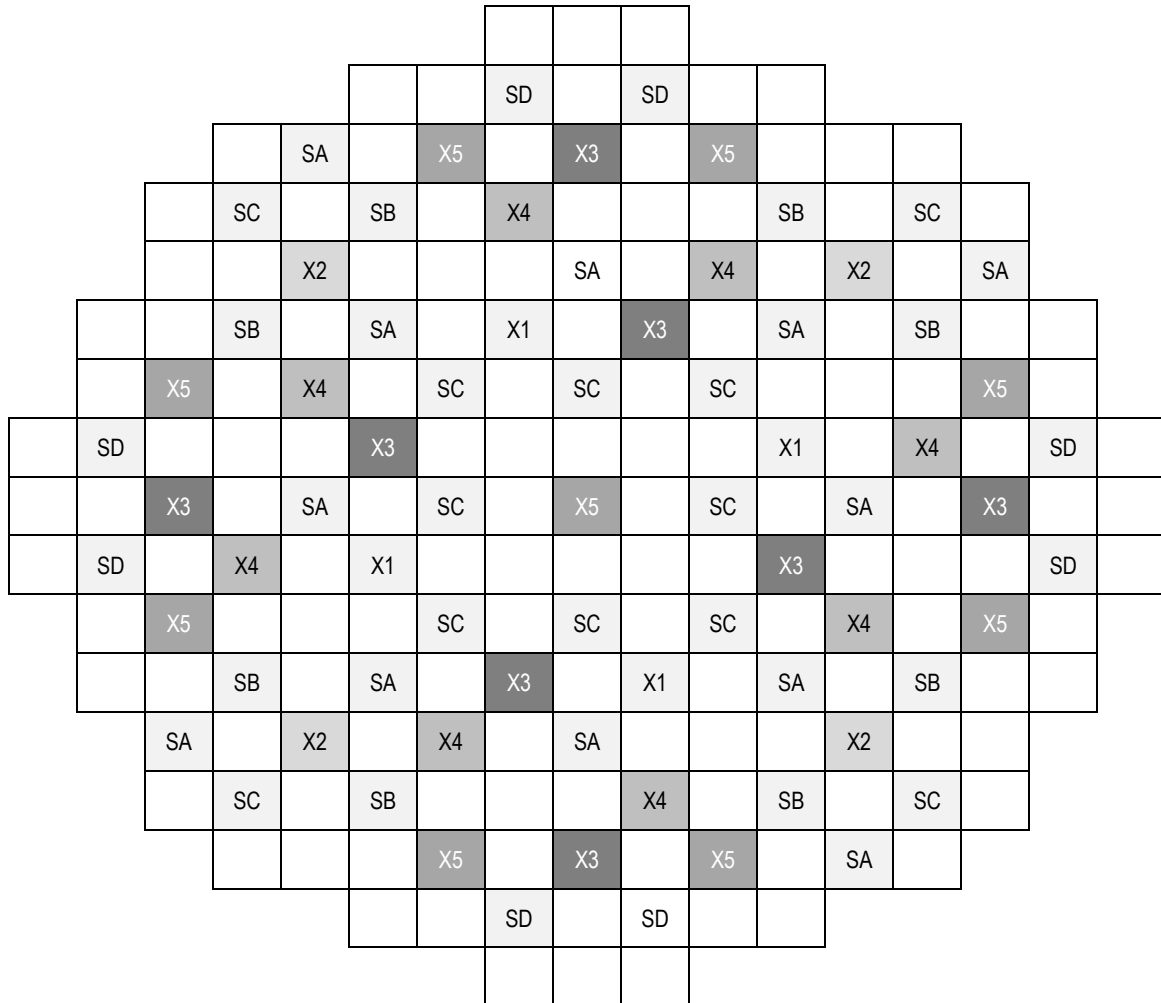

Source: Kerkar and Paulin, 2008.

For the load-following in the mode “X”, the operator of the plant has the following options (the case of power reduction is considered):

- Using the control rods to compensate the xenon poisoning:
 - The advantage of this option is that no additional boric acid is used and thus the volume of the effluents produced is minimal.
 - However, in this case the reactor would not be able to return back to full power if it is required to do so (because the control rods are withdrawn and hence the reactivity margin is small).
- Using the boric acid together with the control rods:
 - The advantage of this option is that the reactor keeps a sufficient reactivity margin allowing fast return to full rated power.

- However, in this case the volume of the effluents associated with the boron regulation is increased.

Two operational regimes were developed for the N4 reactor (for which the mode “X” was developed):

- The regime R corresponding to operation at unit rated power (i.e. base-load situation) and primary frequency regulation in the power interval $\pm 3\% P_r$. The operational mode corresponding to this regime is the mode “A”, with the group D composed of the banks X1,X2,X3, group C of X4 and group B of X5.
- The regime S corresponding to operation at reduced maximal power and in the load-following mode, with a possibility of primary frequency regulation (in the power interval $\pm 3\% P_r$) and secondary frequency regulation (in the power interval $\pm 5\% P_r$). The operating mode corresponding to this regime is the mode “X”. An example of the operation in such mode is illustrated at Figure 3.11.

Figure 3.11: Example of load following in a operational mode X (N4 reactor)

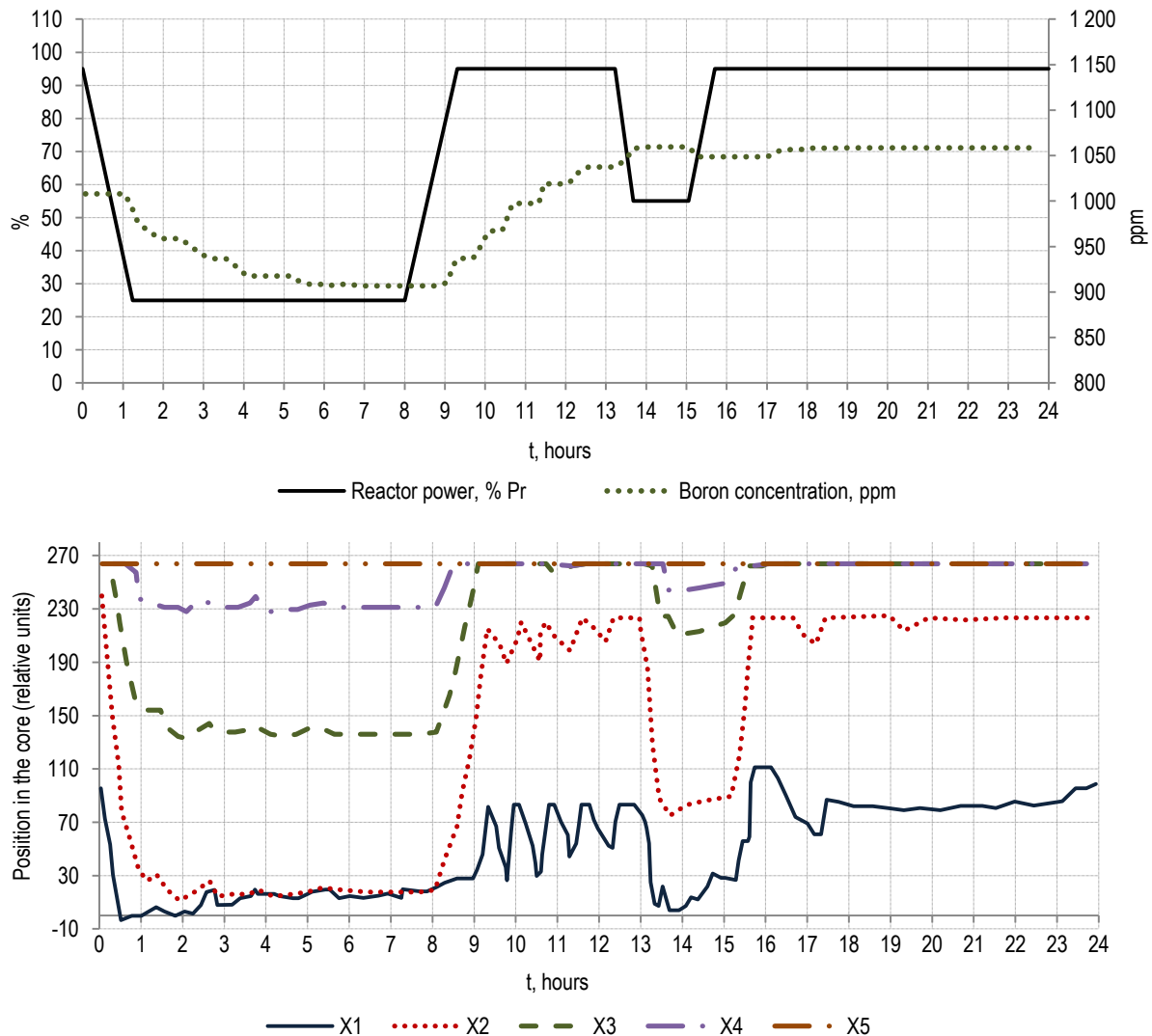

Source: Kerkar and Paulin, 2008.

The mode “X” offers a high degree of manoeuvrability and also allows efficient minimising of the volume of effluents generated during the operation of the plant. Also, it allows controlling the axial power offset and avoiding the xenon oscillations. However, the mode “X” mode is quite complex, and increases the axial irregularity of the fuel burn up (because of control banks inserted to the lower part of the core).

3.2.2 Operation of the NPPs with boiling water reactors (BWRs)

The design of boiling water reactors (BWRs) has considerably evolved through the time (see discussion below and Figure 3.15), if compared to pressurised water reactors. However, the most general difference from the PWR is that in the boiling water reactors (a schematic view is given at Figure 3.12) there is a single circuit, and no steam generators⁴ and pressuriser. The light water (used as coolant and a moderator) boils directly in the core. The steam produced is separated and dried in the upper part of the pressure vessel, and then directly transferred to the turbo generator.

Figure 3.12: General scheme of a conventional boiling water reactor (BWR)

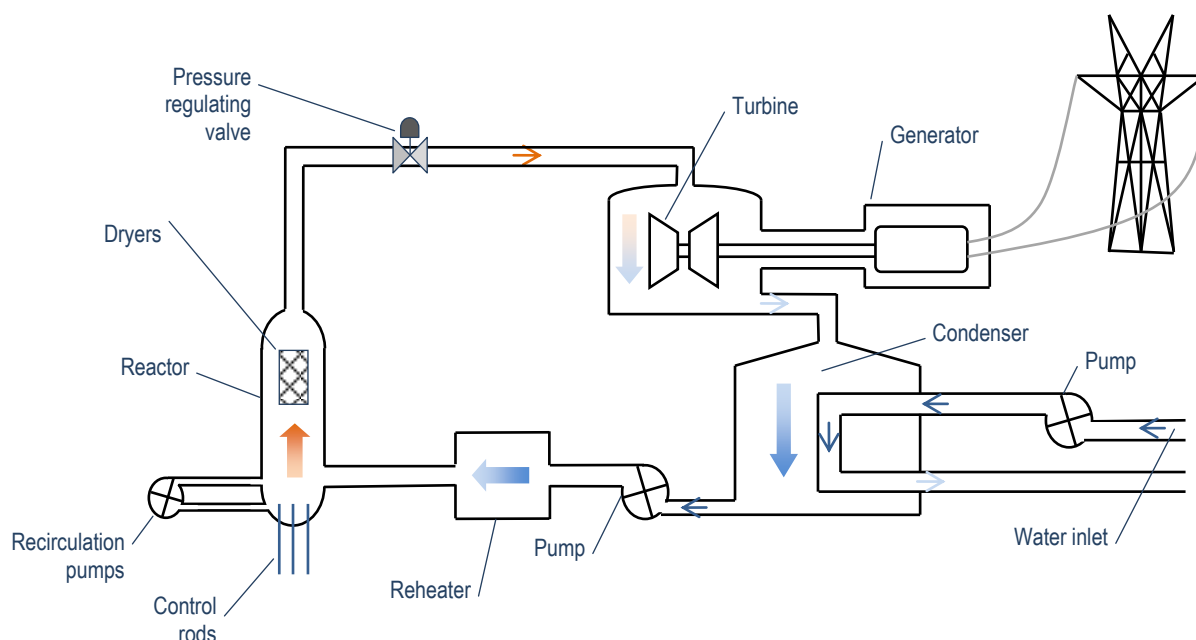

The conventional and some advanced BWRs are operated by changing the coolant flow rate (using the recirculation pumps) and the control rods (see Figure 3.15). No regulation with boric acid is used in BWRs. Some early BWR and the advanced GE ESBWR design only use natural circulation in the vessel and the control rods to control the power from 0% to 100% of the rated power P_r (there are no recirculation pumps, see Figure 3.15.d).

The power regulation by changing the coolant flow rate is taking advantage of negative coolant temperature coefficient of reactivity (see Section 3.1). For example, if the coolant flow rate is increased its temperature (and the amount of boiling) is reduced. In this case the density of the coolant is increased, the neutron moderation becomes more efficient and the overall reactivity is increased.

4. Except the first GE BWR-1 (first unit Dresden 1, United States) that had a dual cycle with a steam generator, see Figure 3.15.

Figure 3.13: Schematic view of a BWR 8×8 fuel element and the control rod (cruciform)

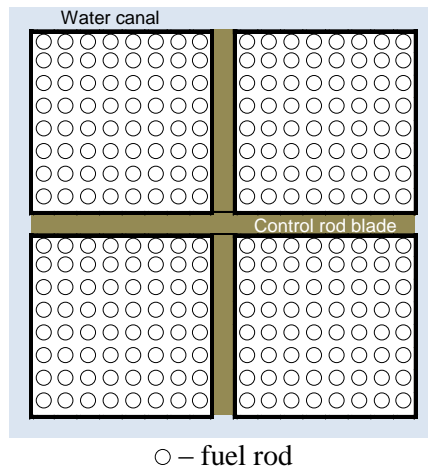

The recirculation controlling of the power is particularly suitable for the load-following in the power interval 60 to 100% P_r (see Figure 3.14). The main advantage of this method is that the power distribution in the core is not changed, contrarily to the regulation with the control rods. Also, this method allows fast power variations with ramps of up to 10% P_r per minute (Ludwig, *et al.*, 2010). Operation below 60% P_r would typically need the use of the control rods.

Figure 3.14: Schematic characteristic curve for BWR power regulation with recirculation pumps

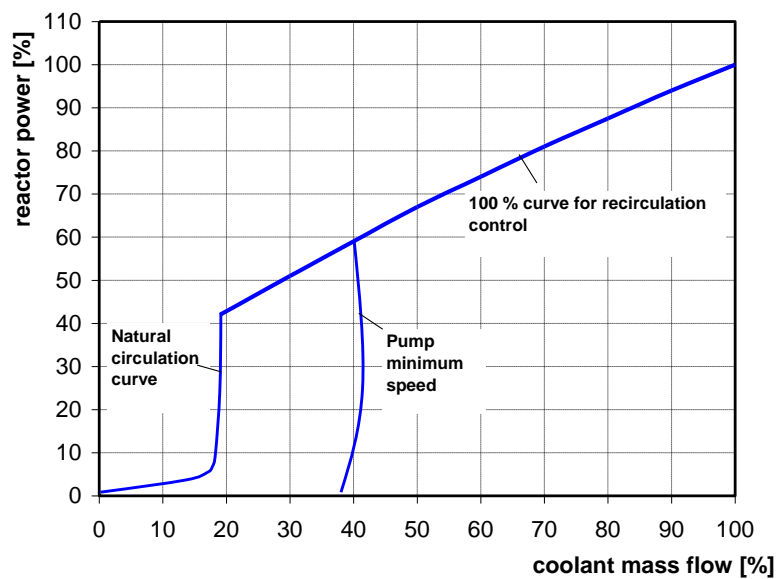

Source: Ludwig, *et al.*, 2010.

As mentioned above, the BWR designs have significantly evolved through the time (see Figure 3.15). The currently deployed advanced BWR may have quite different realisations, for example use in-vessel recirculation pumps or rely on the natural convection in the core. In the latter case, the reactivity is primarily controlled by control rods movement. All advanced boiling water reactors implement fine motion control rod drives (FMCRDs) allowing fine reactivity control.

Figure 3.15: Evolution of the BWR designs

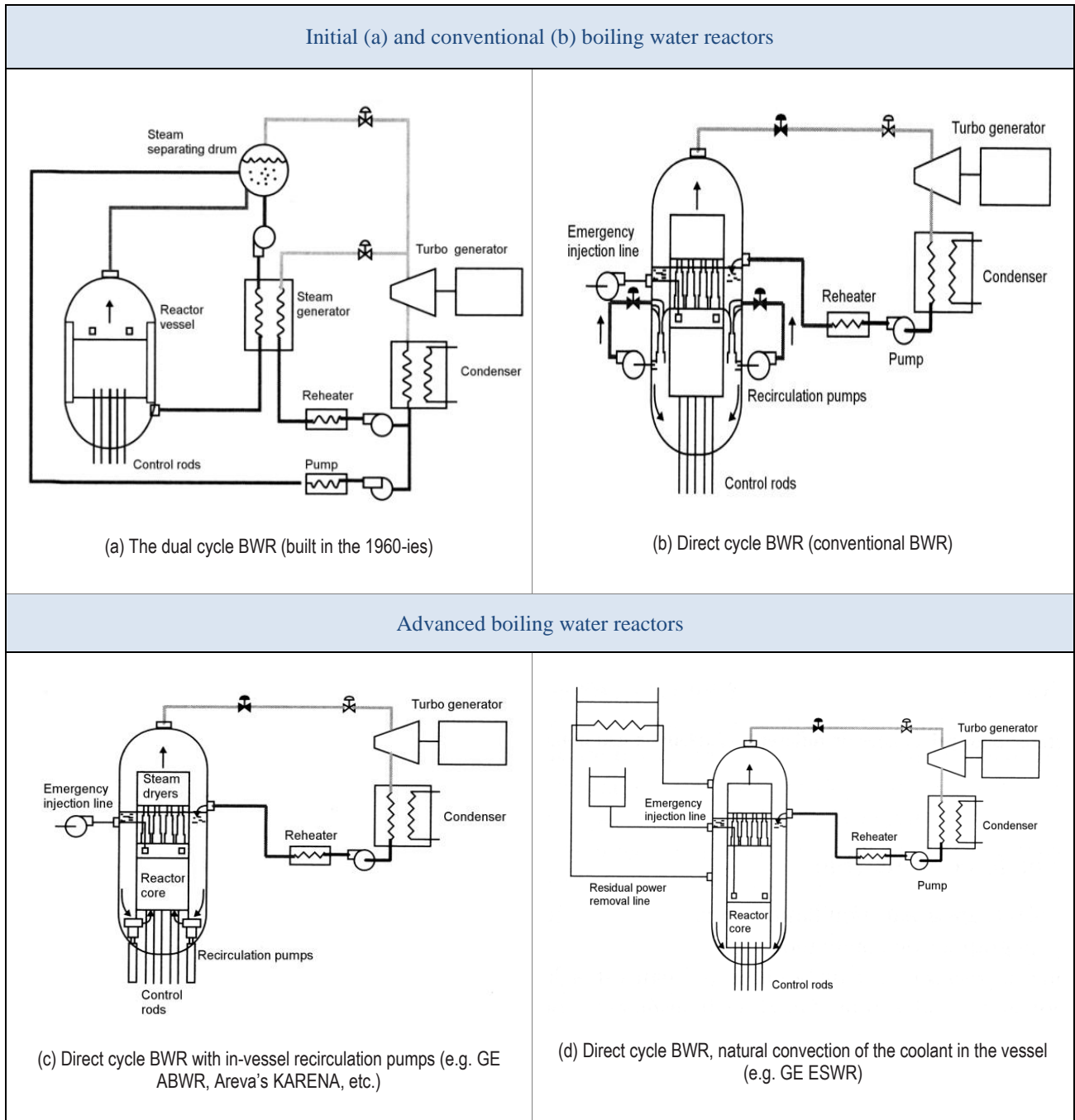

Source: Delhaye, 2008.

3.3 Influence of the load-following on the life-time expectancy of large components

Load cycling leads to variation in the coolant temperature, and thus in the temperatures of different components (see Figure 3.3 and Figure 3.4). These periodic temperature variations lead to cyclic changes in the mechanical load in some parts of the equipment, and could induce localised structural damage (fatigue) of these elements if the temperature gradients are large.

The nuclear power plants are designed for the stress associated with load cycling. Continuous monitoring of equipment fatigue is performed (temperatures measured and recorded, non-destructive material tests, etc.), especially on the safety-related components (Ludwig, *et al.*, 2010).

As an illustration of the analysis and substantiation of the manoeuvrability capability of a recent PWR design, consider the Russian AES-2006 project with VVER-1200 (Andrushechko, *et al.*, 2010). In (Mokhov and Podshibiakin, 2010) the following critical elements (for load following) of the equipment and piping have been identified (see Figure 3.16):

- the spray line (pressuriser) and the branch pipe of the spray line;
- nozzle of the spray line to the cold leg;
- surge line;
- nozzles of the surge line (to the pressuriser and the primary loop);
- steam generator feed water inlet.

It has been shown that the following operation regimes (see Table 2.3 for details) do not decrease the fatigue strength of the equipment:

- operation in the modes corresponding to the frequency regulation: $\pm 5\% P_r$ with ramps of $1\% P_r$ per second);
- reactor power level variation with the speed of more than $1\% P_r$ per minute and less than $5\% P_r$ per minute, and of magnitude of less than $10\% P_r$;
- changing the reactor power by $\pm 10\% P_r$ with the speed of $5\% P_r$ per second.

The total number of cycles in the regimes listed below is limited to 20 000 (see Table 2.3 for details):

- load following (with planned or unplanned schedule) with the speed of less than $5\% P_r$ per minute in the power range $50\% P_r$ to $100\% P_r$ (project documentation limit: 15 000 cycles);
- changing the reactor power by $\pm 20\% P_r$ with the speed of $10\% P_r$ per minute (project documentation limit: 65).

The maximal number of cycles allows operation in the load-following mode during the whole operational lifetime of the plant, with a significant margin: 60 years with 200 cycles per year (in accordance with the EUR requirements, see Section 2.1) or 12 000 cycles per 60 years.

Figure 3.16: VVER-1200 layout and the elements critical for the load following (orange arrows)

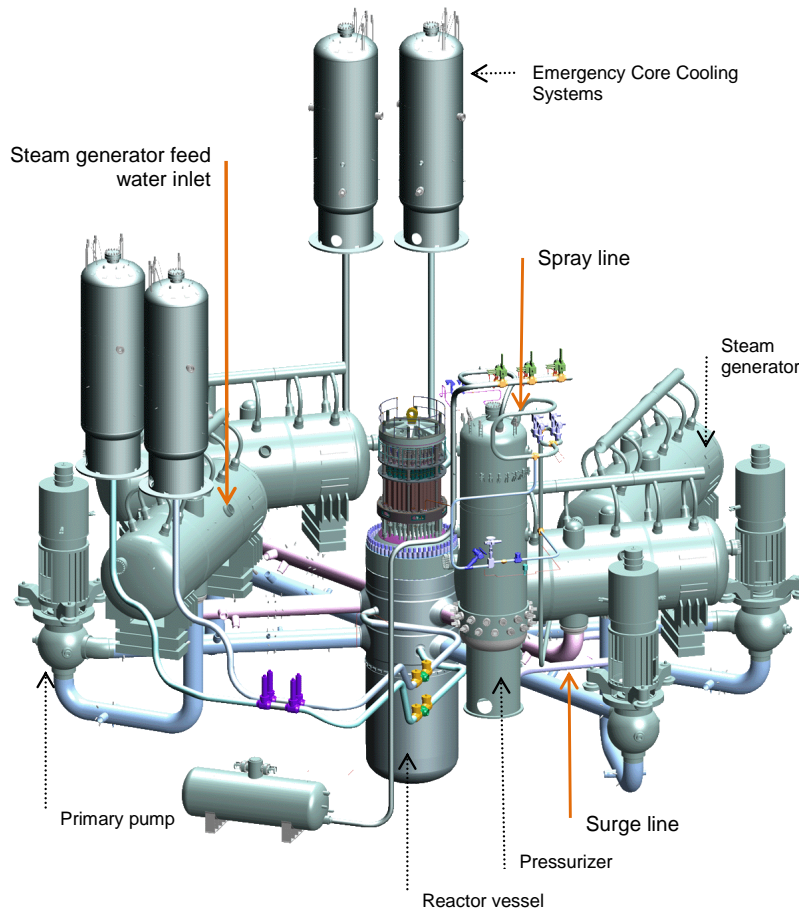

3.4 Fuel performance in the load following mode

One of the most important requirements for load-following (or any significant power variation) is the sufficient level of the fuel reliability. The manoeuvrability of the reactor could be limited by cladding failure due to the pellet-cladding interaction (PCI) and stress corrosion cracking (SCC) and other effects.

In daily load-following (as in some reactors in France or in Germany, see an example at Figure 3.17) the fuel undergoes significant variations of the linear heat generation rate and of the temperature gradient in the pellet. Because of the difference in thermal expansion coefficients of the fuel and cladding materials, the fracturing of the pellets is increased leading to significant increase in releases of corrosive fission gases to the space between the pellet and the cladding.

During the first power increase to the rated power level the pellets usually fracture to several large fragments (4-8 radial sectors and 3-5 axial fragments, see Figure 3.18(a), (b)). This happens because of significant radial temperature gradient in the pellet of more than 100°C per mm (resulting in about 450°C between the center and the edge of the pellet), leading to large internal mechanical stresses. The number of fragments is roughly proportional to the linear heat generation rate. If the local power is significantly increased, more cracks appear and the release of the fission gases to the gap space is accelerated.

Figure 3.17: Example of a typical power history during a cycle in a EDF reactor (in % of the rated power)

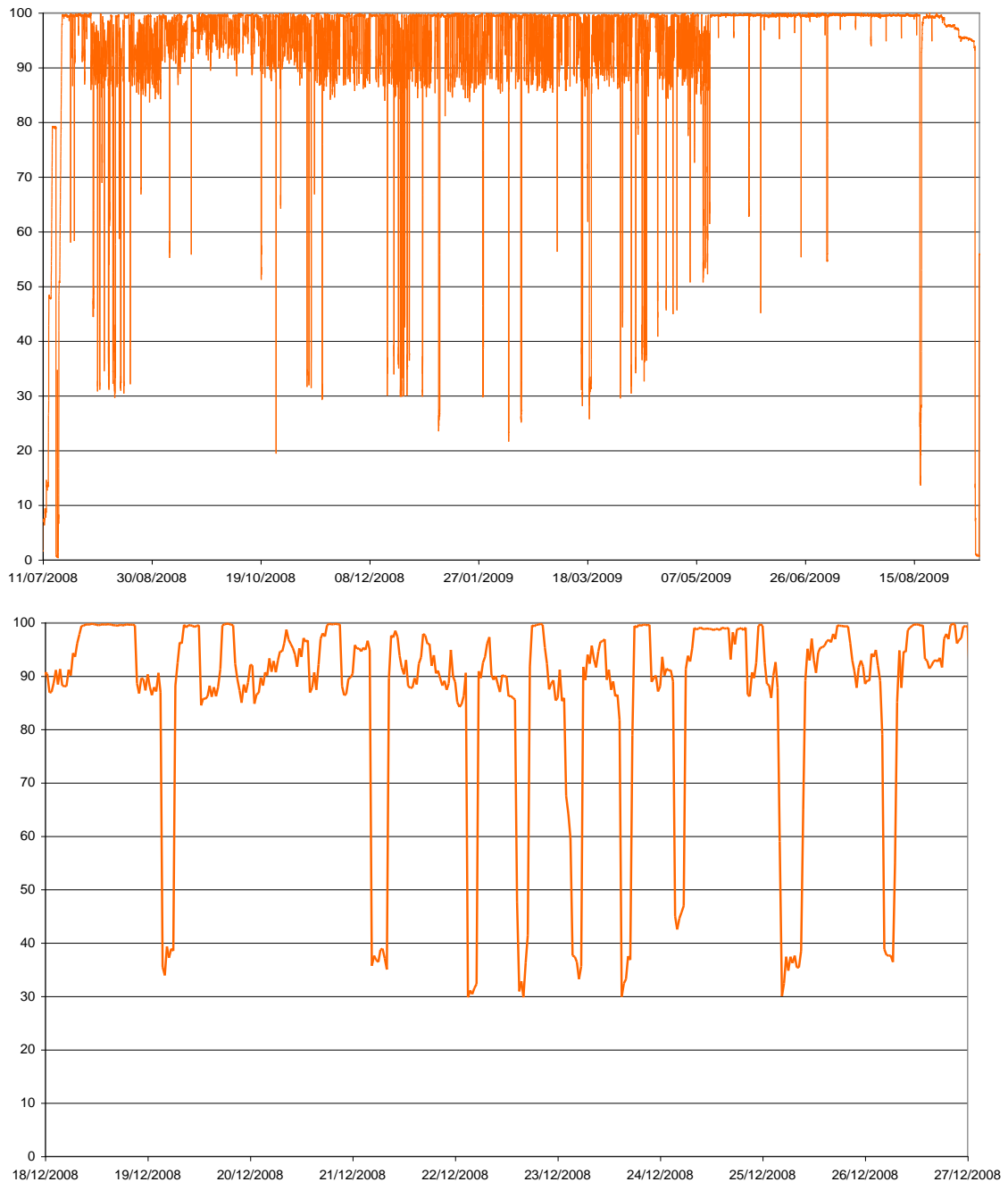

Courtesy of Électricité de France (EDF)

Because of large temperature variations in the fuel pellets (when the linear power changes), the dimensions of the pellet expands and contracts faster than the cladding. In the case of large power variations the pellet fragments can push strongly on the cladding. This effect and the enhanced release of highly corrosive fission gases (through the cracks) could lead to stress corrosion cracking (see Figure 3.18[c]) and failure of the fuel cladding, if the rate of power variations is not limited.

There is a certain limit value of the linear heat generating rate, below which the power variations are safe for the PCI, because the deviation between the clad creep and pellet swelling remains in the allowed frame, and thus, the fuel and the cladding can adapt to the new power level (IAEA, 2010a).

Only a limited number of PCI-related PWR fuel failures have been observed recently, according to (IAEA, 2010a). The operational mode of the PWR avoids local increases of the linear heat generation rates, using the boron regulation or the “grey” control banks. Boron regulation does not affect the power distribution, and the grey banks do not perturb it too much.

According to reported French experience, daily load cycling and extended reduced power operation, together with the associated control rods movements, do not affect the rate of the fuel failures (Provost and Debes, 2006). Same statement was made for Gemran NPPs (Ludwig, *et al.*, 2010). However, in France, nuclear power plants do not operate in the load-following mode during the first 2 weeks of the fuel cycle and during the last 5-20% of the fuel cycle (depending on the reactor type). In Germany, the experience with the load following comprises ramps of up to 2%P_r/min, i.e. less than provided for in the design.

The case of the BWRs is different because no boron is used to compensate the initial reactivity of the core. Instead, the control rods are inserted into the core, and they are progressively withdrawn with the fuel burn up. Fast movements of the control rods could lead to significant increases of the linear heat generation rates. To a large extent, this issue has been solved (IAEA, 2010a) by using remedies like Zr liner in the fuel, introducing of fine control rods drives, improvements in the software of the core monitoring and other measures. Also, according to the utilities requirements (see Section 2.1), load-following with the BWRs should be preferably done using the recirculation pumps (this does not affect the power distribution in the core).

Figure 3.18: Cracking of the fuel pellets of a PWR

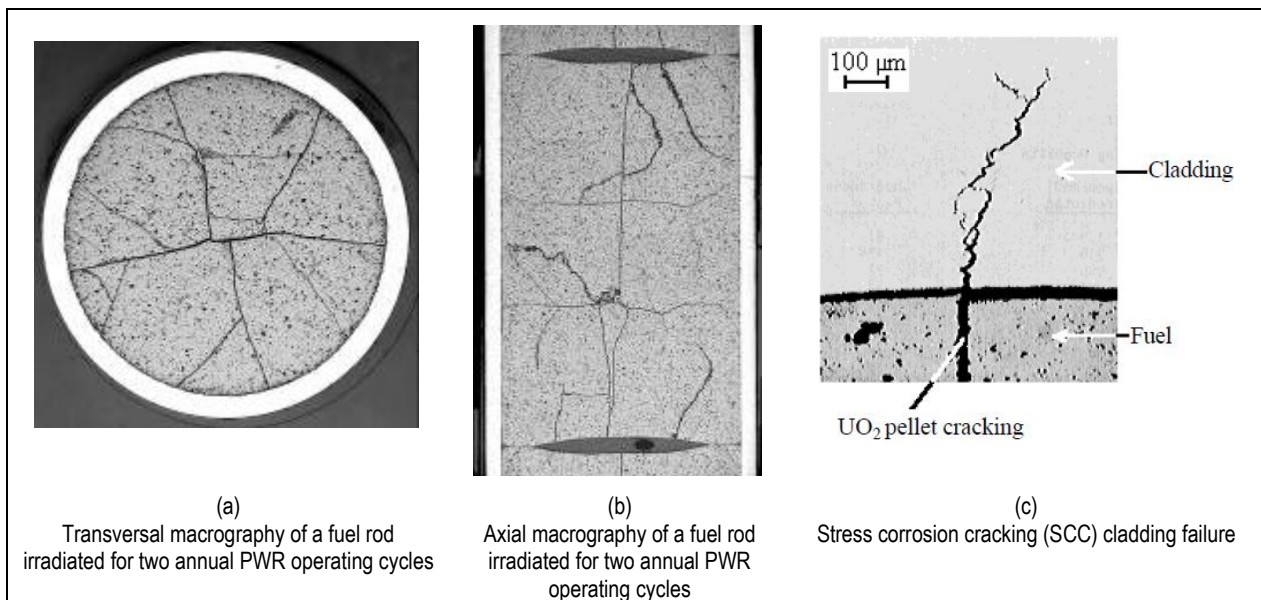

Source: Brochard, *et al.*, 2001.

4 Economic Aspects of Load Following

4.1 Load factor and the cost of electricity generation

The levelised cost of generating electricity LCOE, defined in (IEA/NEA, 2010) as:

$$LCOE = \frac{\sum_t \frac{(\text{Investment}_t + \text{O\&M}_t + \text{Fuel}_t + \text{Carbon}_t + \text{Decommissioning}_t)}{(1+r)^t}}{\sum_t \left(\frac{\text{Electricity}_t}{(1+r)^t} \right)}$$

is quite sensitive to the load factor defining the amount of electricity effectively produced by the plant. The degree of this dependence is a function of the share of the cost of fuel and CO₂ in the total cost. The structure of the total generation costs evaluated in the recent IEA/NEA study “Projected Costs of Generating Electricity” (IEA/NEA, 2010) for the main electricity sources is given in the Table 4.1. In the case of nuclear power, the share of the fuel in the total cost is minimal compared to other sources. At 5% discount rate it represents 16% and at 10% it is 9.5%. Thus, the cost of electricity generated at nuclear power plants decreases significantly when the load factor increases. For some other power sources that have very large share of the cost related to fuel (like gas) this dependence is less significant.

Table 4.1: Total Generation Cost Structure

	At 5% discount rate						At 10% discount rate					
	Nuclear	Coal	Coal w. CCS	Gas	Wind	Solar	Nuclear	Coal	Coal w. CCS	Gas	Wind	Solar
Total Investment Cost	58.6	25.9	51.6	11.1	76.5	91.7	75.6	39.8	66.8	17.3	83.8	94.9
O&M	25.2	9.2	21.9	5.2	22.7	7.3	14.9	7.5	15.1	4.9	16.0	4.9
Fuel Costs*	16.0	27.9	21.0	71.3	0.0	0.0	9.5	22.8	14.5	66.4	0.0	0.0
CO2 Costs	0.0	36.8	5.2	12.3	0.0	0.0	0.0	29.9	3.6	11.4	0.0	0.0
Decommissioning	0.3	0.1	0.2	0.1	0.8	1.0	0.0	0.0	0.0	0.0	0.2	0.3

*Fuel costs for nuclear comprise the costs of the full nuclear fuel cycle including spent fuel reprocessing or disposal.

Source: IEA/NEA, 2010.

Let us quantify the dependence of LCOE on the average load factor. According to the IAEA PRIS database definition, the load factor is (IAEA, 2010b)

$$LF (\%) = \frac{EG}{REG} \times 100$$

where REG is the reference energy generation, i.e. the net electrical energy (in MWh), which would have been supplied when a unit is continuously operated at the reference unit power during the entire reference period, and EG the net electrical energy supplied during the reference period as measured at the unit outlet terminals, i.e. after deducting the electrical energy taken by unit auxiliaries and the losses in transformers that are considered integral parts of the unit.

If \overline{LF} is the average load factor for a plant, the dependence of LCOE on \overline{LF} (compared to some reference load factor $ref\%$) could be expressed as:

$$LCOE(\overline{LF}) = LCOE(ref\%) \left(\frac{ref\%}{\overline{LF}} + \left(1 - \frac{ref\%}{\overline{LF}} \right) \frac{LCOE(ref\%)_{Fuel+CO2}}{LCOE(ref\%)} \right)$$

The relative variation of LCOE as function of the average load factor, corresponding to the factor in brackets of the equation above and based on the data⁵ from the Table 4.1 is given at Figure 4.1 for 5% and 10% discount rates. In agreement with the discussion above, the cost of electricity generated at nuclear power plants strongly depends on the average value of the load factor.

Figure 4.1: Variation of LCOE as function of the load factor for main power sources

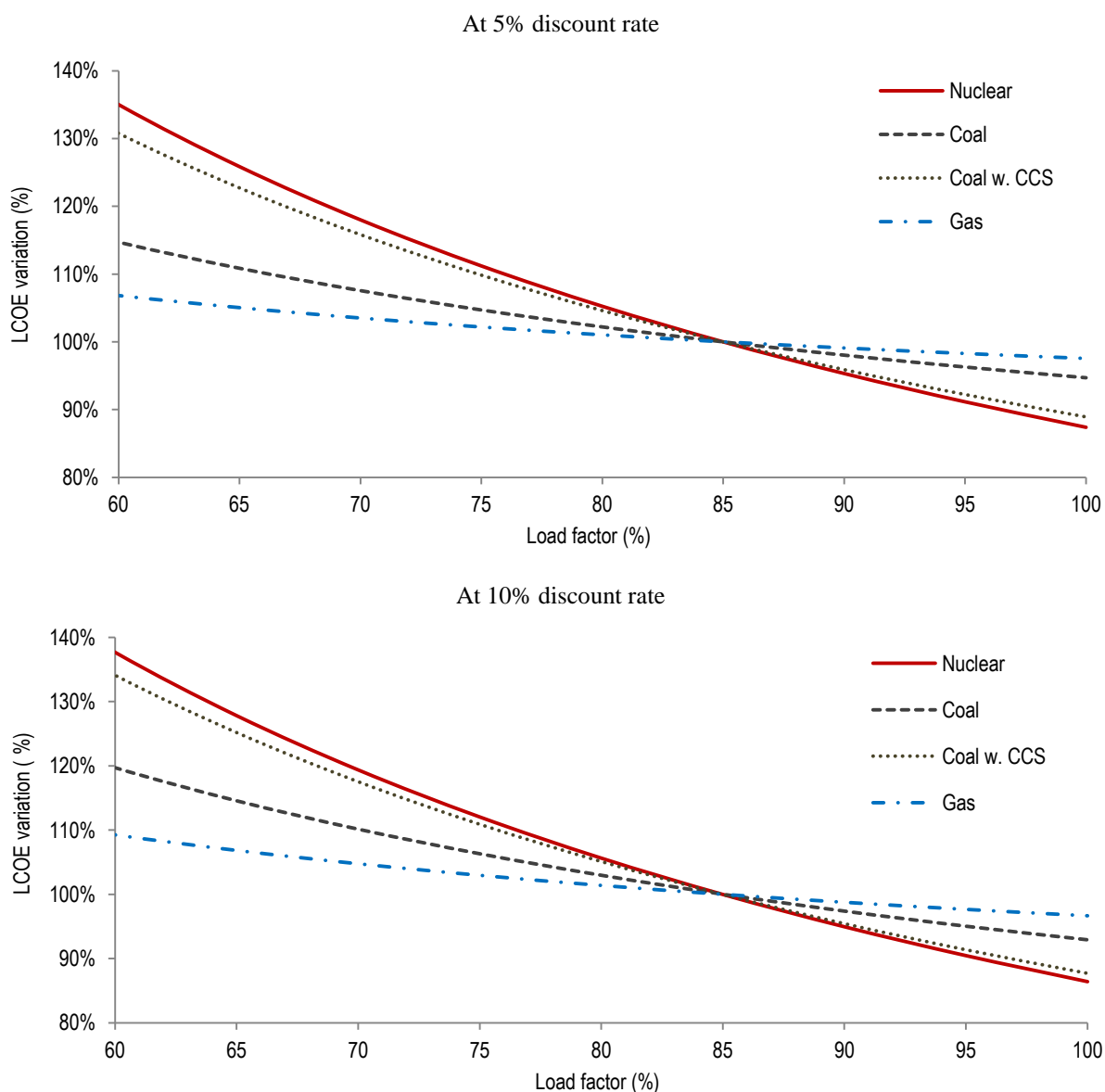

Source: IEA/NEA, 2010.

5. In Table 4.1, the availability factor assumed for nuclear, coal and gas power plants is 85%.

The average energy availability factor of nuclear power plants in the world is about 79% in 2009 (IAEA, 2010b). However, according to the PRIS database, the average availability factor of the top 25% of the plants is 92%.

Load-following leads to a decrease of the average load factor \overline{LF} . For some of the daily load pattern examples from Figure 1.7 it could be more than 10%. However, in practice the decrease of the load factor due to load following is much less important, because usually only a fraction of the nuclear fleet operates in load-following mode. In France, where load following with the nuclear power plants is widely used, the impact of load following on the unit capacity factor (IAEA, 2010b) is estimated to be about 1.2%. According to (EC JRC, 2010), this impact could be majored by 2%.

Figure 4.2: The projected costs of generating electricity as a function of the load factor

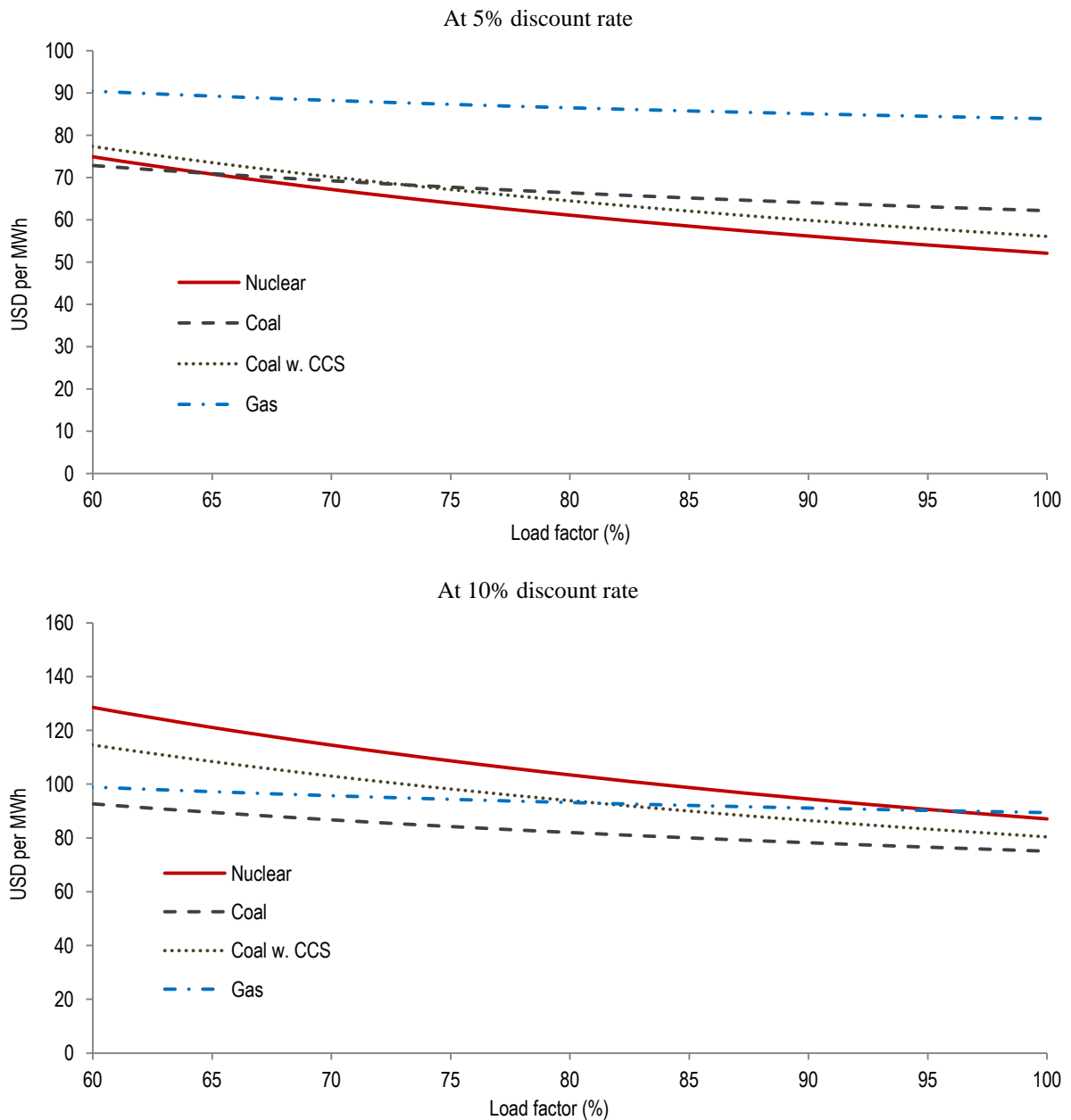

Source: Based on the median case of the projected costs in IEA/NEA, 2010.

The Figure 4.2 illustrates the influence of the load factor on the total cost of generating electricity. It is based on the median cost estimates for the OECD economies presented in (IEA/NEA, 2010). If the average load factor for the nuclear power plants is below a certain limit (about 65% at 5% discount rate), their competitive position would be reduced.

Currently, the average load factor is sufficiently high and the interest rate small enough, so that the influence of load-following on the LCOE could probably be considered as not dramatically affecting the competitiveness of nuclear power in regulated markets. However, in case of higher discount rates the increase of LCOE for the nuclear electricity due to the reduction of the load factor because of load-following could become significant (see the graph corresponding to 10% discount rate at Figure 4.2).

4.2 Influence of the load-following on the equipment and the fuel

According to the current utilities requirements (i.e. the EUR) nuclear power plants should implement significant manoeuvrability capabilities, including the operation in a load-following mode. As we have seen in the Section 3.4, the designers of the modern power plants build the manoeuvrability capabilities into the reactor projects. Thus one could consider that no additional significant investment into the equipment would be needed to use the manoeuvring capabilities of the recent designs.

Some reactor vendors have implemented strong manoeuvring capabilities at the end of the 1980, this is why each nuclear power plant should be analysed individually to determinate the investment needed to allow the desired degree of manoeuvrability.

As can be concluded from the evolution of the operation modes of the PWR (see Section 3.2.2), the design of the nuclear power plants has significantly evolved since the 1970 to achieve the high degree of manoeuvrability of the modern plants. This evolution was possible thanks to significant improvements in the measurements of the physical parameters of the reactor core and the equipment, monitoring of the equipment, introduction of the grey banks for the PWR, optimisation of the fuel rods and pellets, and of the whole instrumentation and control systems.

Many of the existing NPPs with light water reactors have been upgraded to improve their operational performance, including the manoeuvrability capabilities. According to the French and German experience, daily load cycling and extended reduced power operation, together with the associated control rods movements, do not affect the rate of the fuel failures.

Generally speaking, all these achievements indicate that the operation in the load-following mode does not lead to any large additional costs attributable to it (e.g. safety related components, fuel etc.), especially for the recent power plants. However, there is some influence of the load-following on the ageing of some operational components (e.g. valves), and one can expect a slight increase of the maintenance costs.

5 Conclusions

Modern nuclear plants with light water reactors have strong manoeuvring capabilities. Nuclear power plants in France and in Germany operate in load-following mode, i.e. participate in the primary and secondary frequency control, and some units follow a variable load programme with one or two large power changes per day. In France, load-following is needed to balance daily and weekly power variations of the electricity supply and demand, since nuclear power plants have a large share in the national mix. In Germany, load-following became important in recent years when a large share of intermittent sources of electricity generation (e.g. wind) was introduced to the national mix.

The minimum requirements for the manoeuvrability capabilities of the modern reactors are defined by the utilities requirements that are based on the requirements of the grid operators. For example, according to the current version of the European Utilities Requirements (EUR) the NPP must at least be capable of daily load cycling operation between 50% and 100% of its rated power P_r , with a rate of change of electric output of 3-5% of P_r per minute.

Most of the modern designs implement even higher manoeuvrability capabilities, with the possibility of planned and unplanned load-following in the wide power range and with ramps of $5\%P_r$ per minute. Some designs are capable of extremely fast power modulations in the frequency regulation mode with ramps of several percent of the rated power per second, in the narrow band around the power level.

The economic consequences of load-following are mainly related to the reduction of the load factor. In the case of nuclear, fuel costs represent a small fraction of the electricity generating cost, if compared with fissile sources. Thus, operating at higher load factors is profitable for nuclear power plants, since they cannot make savings on the fuel cost while not producing electricity. In France, the impact of load-following on the average unit capability factor is sometimes estimated as about 1.2%.

Since most of the currently used nuclear power plants implement strong manoeuvrability capabilities in their designs (except for some very old NPPs), there is no or very small impact (within the design margins) of the load-following on acceleration of ageing of large equipment components. However, there is some influence of the load-following on the ageing of some operational components (e.g. valves), and thus one can expect a slight increase of the maintenance costs. Also, for older plants some additional investment could be needed, especially in instrumentation and control, in order to become eligible for operation in the load-following mode.

6 References

- Andrushechko, S.A., *et al.*, (2010) “АЭС с реактором типа ВВЭР-1000” (“NPPs with VVER-1000”), in Russian, Moscow, Russian Federation, 2010. ISBN: 978-5-98704-496-4
- Areva (2008), Presentation "Newbuild EPR Reactors", Ankara, Turkey, September 2008. Available at: www.nuke.hun.edu.tr/tr/webfiles/Activities/wnu/18%20sept/Othman%20Salhi/4Newbuild%20EPR%20reactors.pdf.
- Aminov R.Z., *et al.*, (1990), “АЭС с ВВЭР: Режимы, Характеристики, Эффективность”, (NPP with VVER: Regimes, Characteristics, Efficiency) (in Russian), Energoatomizdat, 1990, Moscow, Russian Federation.
- Brochard, J., *et al.*, (2001), “Modelling of Pellet Cladding Interaction in PWR fuel”, SMiRT 19, Washington DC, United States, August 2001. Available at: www.iasmirt.org/SMiRT16/C1314.PDF
- Cappolani, P, *et al.*, (2004), “La chaudière des réacteurs à eau sous pression”, EDP Sciences, 2004, France.
- Delhayе Jean-Marc (2008), “Thermohydraulique des réacteurs”, EDP Sciences, 2008, France.
- Dragunov Y.G. *et al.*, (2007), “Project of the active zone of AES-2006 reactor” (in Russian), Proceedings of MNTK-2007 conference, 2007, Moscow. Russian Federation. Available at: www.gidropress.podolsk.ru/files/proceedings/mntk2007/f140.pdf
- EC JRC (2010), “Load-following operating mode at Nuclear Power Plants (NPPs) and incidence on Operation and Maintenance (O&M) costs. Compatibility with wind power variability”, European Commission, Joint Research Centre, Institute for Energy, SPNR/POS/10 03 004 Rev. 05. http://publications.jrc.ec.europa.eu/repository/bitstream/11111111/15308/1/reqno_jrc60700_ldna24583enc.pdf%5B1%5D.pdf
- EUR (2001), *The European Utility Requirement (EUR) document*, Volume 2 revision C, April 2001.
- IAEA (2010a), *Review of Fuel Failures in Water Cooled Reactors*, Nuclear Energy Series No. NF-T-2.1, Vienna, Austria.
- IAEA (2010b), *Operating Experience with Nuclear Power Stations in Member States in 2009*, IAEA, Vienna, Austria.
- IEA/NEA (2010), *Projected Costs of Generating Electricity: 2010 edition*, International Energy Agency, OECD, Paris, France.
- Ludwig, H., *et al.*, (2010), “Load cycling capabilities of German Nuclear Power Plants”, Vol. 55, No. 8, August/September, *International Journal for Nuclear Power*. Available at: http://en.kernenergie.de/kernenergie/documentpool/Aug-Sept/atw2010_09_waas_lastwechselfaehigkeit_kkw_en.pdf

Mokhov, V.A and M.A, Podshibiakin (2010) “Обоснование проектов реакторных установок ВВЭР 1000/1200 при работе АЭС в маневренных режимах”, (Study of the NPP with VVER-1000/1200 reactors operation in manoeuvrable mode), Proceedings of the Energia-2010 conference (in Russian), pp. 103-106, 1-3 June 2010, Moscow, Russian Federation. Available at: www.energy2010.mpei.ru/_Files/Proceedings1.pdf

Kerkar, N. and P. Paulin (2008), “Exploitation des coeurs REP”, EDP Sciences, 2008, France.

Provost, L. and M. Debes (2006), “EDF PWR fuels operating experience and high burn performances”, Proceedings of TopFuel-2006, Salamanca, 2006.

UK-EPR (2009), “Pre-Construction Safety Report”, UK EPR-0002-012 Issue 01, 2009. Available at: www.epr-reactor.co.uk/ssmod/liblocal/docs/PCSR/Chapter%20%201%20-%20Introduction%20and%20General%20Description/Sub-Chapter%201.2%20-%20General%20Description%20of%20the%20Unit.pdf